

ASME B16.10-2000
(Revision of ASME B16.10-1992)

FACE-TO-FACE AND END-TO-END DIMENSIONS OF VALVES

AN AMERICAN NATIONAL STANDARD



The American Society of
Mechanical Engineers



The American Society of
Mechanical Engineers

A N A M E R I C A N N A T I O N A L S T A N D A R D

FACE-TO-FACE AND END-TO-END DIMENSIONS OF VALVES

ASME B16.10-2000
(Revision of ASME B16.10-1992)

Date of Issuance: June 15, 2001

This Standard will be revised when the Society approves the issuance of a new edition. There will be no addenda issued to this edition. The next edition of this Standard is scheduled for publication in 2005.

ASME will issue written replies to inquiries concerning interpretation of technical aspects of this Standard.

ASME is the registered trademark of The American Society of Mechanical Engineers.

This code or standard was developed under procedures accredited as meeting the criteria for American National Standards. The Standards Committee that approved the code or standard was balanced to assure that individuals from competent and concerned interests have had an opportunity to participate. The proposed code or standard was made available for public review and comment that provides an opportunity for additional public input from industry, academia, regulatory agencies, and the public-at-large.

ASME does not "approve," "rate," or "endorse" any item, construction, proprietary device, or activity.

ASME does not take any position with respect to the validity of any patent rights asserted in connection with any items mentioned in this document, and does not undertake to insure anyone utilizing a standard against liability for infringement of any applicable letters patent, nor assume any such liability. Users of a code or standard are expressly advised that determination of the validity of any such patent rights, and the risk of infringement of such rights, is entirely their own responsibility.

Participation by federal agency representative(s) or person(s) affiliated with industry is not to be interpreted as government or industry endorsement of this code or standard.

ASME accepts responsibility for only those interpretations of this document issued in accordance with the established ASME procedures and policies, which precludes the issuance of interpretations by individuals.

No part of this document may be reproduced in any form,
in an electronic retrieval system or otherwise,
without the prior written permission of the publisher.

The American Society of Mechanical Engineers
Three Park Avenue, New York, NY 10016-5990

Copyright © 2001 by
THE AMERICAN SOCIETY OF MECHANICAL ENGINEERS
All Rights Reserved
Printed in U.S.A.

FOREWORD

In 1921 the American Engineering Standards Committee, later the American Standards Association (ASA), organized Sectional Committee B16 to unify and further develop national standards for pipe flanges and fittings (and, later, for valves, gaskets, and valve actuators). Cosponsors of the B16 Committee were the American Society of Mechanical Engineers (ASME), the Heating and Piping Contractors National Association [(now the Mechanical Contractors Association of America (MCAA)], and the Manufacturers Standardization Society of the Valve and Fittings Industry (MSS). Cosponsors were later designated as cosecretariat organizations.

Pioneer work on standardization of end-to-end dimensions of valves began in 1917 under the direction of J. A. Stevens. It was put aside at the end of World War I and interest did not revive until 1926. ASA and ASME agreed to include the topic in the scope of the B16 Committee, and Subcommittee 5 (now Subcommittee E) was established for the purpose. Work began in 1928 and covered ferrous flanged-end gate, globe, angle, and check valves.

Development of a national standard was hindered by the diversity of existing practices and by adverse economic conditions in the early 1930s. A proposed 1933 American Standard for face-to-face dimensions of ferrous flanged valves did not gain acceptance, even though it was largely based on a 1931 Standard Practice of MSS. Further work and industry developments led to a meeting in May 1937, which undertook to reconcile differences among the draft ASA standard, two American Petroleum Institute (API) standards (5-G-1 on pipeline valves and 600A on flanged OS&Y steel wedge gate valves), and a newly updated MSS SP-32.

A revised B16 proposal was voted favorably in June 1938, was approved by ASA, and was published in 1939. The standard was reaffirmed in 1947. Work began on a revision in 1953 to include buttwelding end valves, plug valves, and control valves in both cast iron and steel. That edition was published as ASA B16.10-1957. Further revision was begun in 1964. After reorganization of ASA, first as the United States of America Standards Institute (USASI), then as American National Standards Institute (ANSI), with the Sectional Committee being redesignated as an American National Standards Committee, a new edition adding ball valves was approved and published as ANSI B16.10-1973.

In 1982 American National Standards Committee B16 was reorganized as an ASME Committee operating under procedures accredited by ANSI. In the 1986 Edition, ductile iron and the alloys covered by ANSI B16.34 were added to the materials covered. Wafer type gate and check valves, Class 150 Y-pattern globe and check valves, and several patterns of butterfly valves were added to the types covered. Inch dimensions were converted from common to two-place decimal fractions.

In 1991 Subcommittee E — Face-to-Face and End-to-End Dimensions of Valves, was combined with Subcommittee N — Steel Valves. In the 1992 Edition, steel offset seat and grooved end butterfly valves were added. Globe and flangeless style control valves, which previously had been included, were removed from the Standard. Information regarding control valve dimensions may be obtained from Instrument Society of America, 67 Alexandria Drive, Research Triangle Park, NC 27709.

In this 2000 Edition, metric dimension tables were added. All tables and references to Class 400 steel and Class 800 cast iron were removed. All tables were renumbered.

Requests for interpretations or suggestions for revisions should be sent to the Secretary, B16 Committee, The American Society of Mechanical Engineers, Three Park Avenue, New York, NY 10016.

Following approval by the B16 Main Committee and the ASME Supervisory Board, this Standard was approved as an American National Standard by ANSI on June 7, 2000.

ASME B16 COMMITTEE

Standardization of Valves, Flanges, Fittings, and Gaskets

(The following is the roster of the Committee at the time of approval of this Standard.)

OFFICERS

W. N. McLean, *Chair*
H. R. Sonderegger, *Vice Chair*
S. J. Rossi, *Secretary*

COMMITTEE PERSONNEL

R. W. Barnes, Anric Enterprises, Ontario, Canada
R. R. Brodin, Fisher Controls International, Inc., Marshalltown, Iowa
M. A. Clark, Nibco, Inc., Elkhart, Indiana
A. Cohen, Consultant, Albuquerque, New Mexico
C. E. Floren, Mueller Co., Decatur, Illinois
D. R. Frikken, Monsanto Co., St. Louis, Missouri
G. A. Jolly, Edward Vogt Valve Co., Jeffersonville, Indiana
W. G. Knecht, BW/IP International, Williamsport, Pennsylvania
R. Koester, The William Powell Co., Cincinnati, Ohio
W. N. McLean, Newco Valves, Palos Park, Illinois
M. L. Nayyar, Bechtel Power Corp., Frederick, Maryland
R. A. Schmidt, Ladish Co., Russellville, Arkansas
H. R. Sonderegger, TYCO Flow Control, Cranston, Rhode Island
W. M. Stephan, Flexitallic, Inc., Mount Laurel, New Jersey
T. F. Stroud, Ductile Iron Pipe Research Association, Birmingham, Alabama
M. D. Wasicek, American Bureau of Shipping, Houston, Texas
D. A. Williams, Southern Company Services, Birmingham, Alabama
L. A. Willis, Dow Chemical Co., Freeport, Texas
W. R. Worley, Union Carbide Corp., South Charleston, West Virginia

SUBCOMMITTEE N — STEEL VALVES

W. N. McLean, *Chair*, Newco Valves, Palos Park, Illinois
S. J. Rossi, *Secretary*, The American Society of Mechanical Engineers, New York, New York
E. A. Bake, Consultant, Cary, North Carolina
D. R. Frikken, Solutia, Inc., St. Louis, Missouri
G. R. Icenogle, Fisher Controls International, Inc., Marshalltown, Iowa
G. A. Jolly, Edward Vogt Valve Co., Jeffersonville, Indiana
R. J. Kiessel, Consultant, Livingston, Texas
W. G. Knecht, BW/IP International, Inc., Williamsport, Pennsylvania
M. L. Nayyar, Bechtel Corp., Gaithersburg, Maryland
F. R. O'Brien, Crane Pacific Valves, Long Beach, California
G. J. Paptzun, George J. Paptzun, PE, Lansdale, Pennsylvania
D. W. Raho, CCM 2000, Rockaway, New Jersey
H. R. Sonderegger, Grinnell Corp., Cranston, Rhode Island
F. C. Tsao, Department of Navy, Washington, DC
M. D. Wasicek, ABS Americas, Houston, Texas

CORRESPONDENCE WITH THE B16 COMMITTEE

General. ASME Standards are developed and maintained with the intent to represent the consensus of concerned interests. As such, users of this Standard may interact with the Committee by requesting interpretations, proposing revisions, and attending Committee meetings. Correspondence should be addressed to:

Secretary, B16 Main Committee
The American Society of Mechanical Engineers
Three Park Avenue
New York, NY 10016-5990

Proposing Revisions. Revisions are made periodically to the Standard to incorporate changes that appear necessary or desirable, as demonstrated by the experience gained from the application of the Standard. Approved revisions will be published periodically.

The Committee welcomes proposals for revisions to this Standard. Such proposals should be as specific as possible, citing the paragraph number(s), the proposed wording, and a detailed description of the reasons for the proposal, including any pertinent documentation.

Interpretations. Upon request, the B16 Committee will render an interpretation of any requirement of the Standard. Interpretations can only be rendered in response to a written request sent to the Secretary of the B16 Main Committee.

The request for interpretation should be clear and unambiguous. It is further recommended that the inquirer submit his/her request in the following format:

Subject: Cite the applicable paragraph number(s) and the topic of the inquiry.
Edition: Cite the applicable edition of the Standard for which the interpretation is being requested.
Question: Phrase the question as a request for an interpretation of a specific requirement suitable for general understanding and use, not as a request for an approval of a proprietary design or situation. The inquirer may also include any plans or drawings, which are necessary to explain the question; however, they should not contain proprietary names or information.

Requests that are not in this format will be rewritten in this format by the Committee prior to being answered, which may inadvertently change the intent of the original request.

ASME procedures provide for reconsideration of any interpretation when or if additional information that might affect an interpretation is available. Further, persons aggrieved by an interpretation may appeal to the cognizant ASME Committee or Subcommittee. ASME does not "approve," "certify," "rate," or "endorse" any item, construction, proprietary device, or activity.

Attending Committee Meetings. The B16 Main Committee regularly holds meetings, which are open to the public. Persons wishing to attend any meeting should contact the Secretary of the B16 Main Committee.

CONTENTS

Foreword	iii
Standards Committee Roster	v
Correspondence With the B16 Committee	vi
1 Scope	1
2 Definitions	2
3 Facings of Flanged Valves	3
4 Variations of Length Within a Class of Valves	5
5 Tolerances	5
Figures	
1 Flange Facings and Their Relationships	4
2 Welding Ends	5

Tables

Metric Unit Tables

Tables 1 to 10 are formatted using millimeter units.
See para. 1.2 for applicability.

1 Class 125 Cast Iron Flanged and Class 150 Steel Flanged and Buttwelding End Valves, Face-to-Face and End-to-End Dimensions	6
2 Class 250 Cast Iron Flanged and Class 300 Steel Flanged and Buttwelding End Valves, Face-to-Face and End-to-End Dimensions	9
3 Class 600 Steel Flanged and Buttwelding End Valves, Face-to-Face and End-to-End Dimensions	12
4 Class 900 Steel Flanged and Buttwelding End Valves, Face-to-Face and End-to-End Dimensions	14
5 Class 1500 Steel Flanged and Buttwelding End Valves, Face-to-Face and End-to-End Dimensions	15
6 Class 2500 Steel Flanged and Buttwelding End Valves, Face-to-Face and End-to-End Dimensions	17
7 Classes 125 and 250 Cast Iron and Classes 150 to 2500 Steel Wafer Type Valves, Face-to-Face Dimensions	18
8 Classes 25 and 125 Cast Iron and Classes 150 to 600 Steel Butterfly Valves, Face-to-Face Dimensions	19
9 Determination of Face-to-Face and End-to-End Dimensions of Flanged Valves Having Various Flange Facings	20
10 Classes 150 to 2500 Steel Valves Having End Flanges With Ring Joint Facings, End-to-End Dimensions	21

U.S. Customary Unit Tables

Tables A1 to A10 are formatted using inch units.

See para. 1.2 for applicability.

A1	Class 125 Cast Iron Flanged and Class 150 Steel Flanged and Butt welding End Valves, Face-to-Face and End-to-End Dimensions	23
A2	Class 250 Cast Iron Flanged and Class 300 Steel Flanged and Butt welding End Valves, Face-to-Face and End-to-End Dimensions	26
A3	Class 600 Steel Flanged and Butt welding End Valves, Face-to-Face and End-to-End Dimensions	29
A4	Class 900 Steel Flanged and Butt welding End Valves, Face-to-Face and End-to-End Dimensions	31
A5	Class 1500 Steel Flanged and Butt welding End Valves, Face-to-Face and End-to-End Dimensions	32
A6	Class 2500 Steel Flanged and Butt welding End Valves, Face-to-Face and End-to-End Dimensions	34
A7	Classes 125 and 250 Cast Iron and Classes 150 to 2500 Steel Wafer Type Valves, Face-to-Face Dimensions	35
A8	Classes 25 and 125 Cast Iron and Classes 150 to 600 Steel Butterfly Valves, Face-to-Face Dimensions	36
A9	Determination of Face-to-Face and End-to-End Dimensions of Flanged Valves Having Various Flange Facings	37
A10	Classes 150 to 2500 Steel Valves Having End Flanges With Ring Joint Facings, End-to-End Dimensions	38
Mandatory Annex		
I	References	41

FACE-TO-FACE AND END-TO-END DIMENSIONS OF VALVES

1 SCOPE

1.1 General

This Standard covers face-to-face and end-to-end dimensions of straightway valves, and center-to-face and center-to-end dimensions of angle valves. Its purpose is to assure installation interchangeability for valves of a given material, type, size, rating class, and end connection. Face-to-face and center-to-face dimensions apply to flanged end valves with facings defined in para. 2.3.1 and to other valves intended for assembly between flat face or raised face flanges. End-to-end dimensions apply to grooved end, buttwelding end, and flanged end valves with facings defined in para. 2.3.3. Center-to-end dimensions apply to buttwelding end and to flanged end valves with facings defined in para. 2.3.3.

In Tables 1 to 6 (Tables A1 to A6), *A* or *D* in a column head denotes valves having flanged ends as illustrated; *B* or *E* denotes valves having buttwelding ends.

1.2 Standard Units

The values stated in either millimeter units (Tables 1 to 10) or inch units¹ (Tables A1 to A10) are to be regarded separately as standard. Within the text, the inch units are shown in parentheses. The values stated in each system are not exact equivalents; therefore, each system must be used independently of the other. Combining values from the two systems may result in nonconformance with the standard.

¹ Linear inch dimensions in this Standard are expressed using two-place decimal fractions. These values are actually common fractions of an inch rounded to the nearest two-place decimal value as follows:

0.03 = $\frac{1}{32}$	0.44 = $\frac{7}{16}$
0.06 = $\frac{1}{16}$	0.50 = $\frac{1}{2}$
0.12 = $\frac{1}{8}$	0.56 = $\frac{9}{16}$
0.16 = $\frac{5}{32}$	0.62 = $\frac{5}{8}$
0.19 = $\frac{3}{16}$	0.69 = $\frac{11}{16}$
0.22 = $\frac{7}{32}$	0.75 = $\frac{3}{4}$
0.25 = $\frac{1}{4}$	0.88 = $\frac{7}{8}$
0.31 = $\frac{5}{16}$	0.94 = $\frac{15}{16}$
0.38 = $\frac{3}{8}$	

1.3 Cast Iron Valves

Only flanged end valves (and others intended for assembly between flanges) are covered by this Standard. Mating dimensions and facings of flanged ends conform to those in ASME B16.1. Dimensional tables for various types and sizes of valves are as follows.

1.3.1 Gate, Plug, and Check Valves

- (a) Class² 125 — Tables 1 and A1
- (b) Class 250 — Tables 2 and A2

1.3.2 Globe and Angle Valves

- (a) Class 125 — Tables 1 and A1
- (b) Class 250 — Tables 2 and A2

1.3.3 Wafer Swing Check Valves

- (a) Class 125 — Tables 7 and A7
- (b) Class 250 — Tables 7 and A7

1.3.4 Butterfly Valves

- (a) Class 25 — Tables 8 and A8
- (b) Class 125 — Tables 8 and A8

1.4 Ductile Iron Valves

Only flanged end valves (and others intended for assembly between flanges) are covered. Mating dimensions and facings of flanged ends conform to those in ASME B16.42. Valves are rated Class 150 and Class 300. The following cast iron and steel dimensional tables are also used for ductile valves.

- (a) Class 150 — Tables 1 and A1
- (b) Class 300 — Tables 2 and A2

1.5 Steel and Alloy Valves

This category includes carbon, alloy, and stainless steels, and the nonferrous materials listed in ASME B16.34. It includes flanged, buttwelding, and grooved ends, as well as the types of valves intended for assembly between flanges. Mating dimensions and facings of flanged ends conform to those in ASME B16.5,

² For explanation of *Class* and relationship to PN, see para. 2.2.

ASME B16.47, Series A, or MSS SP-44. [For flanged end butterfly valves, refer to Note (3) of Table 8 (A8) for flange information.] For flangeless or wafer valves intended for assembly between flanges, refer to Tables 7 and 8 (A7 and A8) for flange information. Only buttwelding end valves in rating Classes 150 through 2500 are included in this Standard. Dimensional tables for various types and sizes of valves are as follows.

1.5.1 Gate, Globe, Angle, Check, Plug, and Ball Valves

- (a) Class 150 — Tables 1 and A1
- (b) Class 300 — Tables 2 and A2
- (c) Class 600 — Tables 3 and A3
- (d) Class 900 — Tables 4 and A4
- (e) Class 1500 — Tables 5 and A5
- (f) Class 2500 — Tables 6 and A6

1.5.2 Y-Pattern Globe and Y-Pattern Swing Check Valves

Class 150 — Tables 1 and A1

1.5.3 Wafer Knife Gate Valves

Class 150 — Tables 7 and A7

1.5.4 Wafer Swing Check Valves

Class 150 to 2500 — Tables 7 and A7

1.5.5 Butterfly Valves

- (a) Class 150 — Tables 8 and A8
- (b) Class 300 — Tables 8 and A8
- (c) Class 600 — Tables 8 and A8

1.6 Convention

For the purpose of determining conformance with this Standard, the convention for fixing significant digits where limits, maximum or minimum values, are specified shall be "rounding off" as defined in ASTM Practice E29. This requires that an observed or calculated value shall be rounded off to the nearest unit in the last right-hand digit used for expressing the limit. Decimal values and tolerance do not imply a particular method of measurement.

2 DEFINITIONS

2.1 Valve Size Designation

2.1.1 (DN) (Nominal Diameter). The size of a valve is designated by the nominal size of its end connections. This is denoted by (DN), a dimensionless number indirectly related to the physical size of the

connecting pipe (See Tables 1 through 10). The valve size is not necessarily the same as the inside diameter or port diameter.

2.1.2 NPS (Nominal Pipe Size). The size of a valve is designated by the nominal size of its end connections. This is denoted by NPS, a dimensionless number indirectly related to the physical size of the connecting pipe (See Tables A1 through A10). The valve size is not necessarily the same as the inside diameter or port diameter.

2.1.3 Reduced port, gate, and ball valves conforming to API 6D are designated for size by two numbers, the first being the NPS (DN) on the valve ends, the second being the NPS (DN) of the port (seats, moving parts, etc.); e.g., NPS 6 × 4 (DN 150 × 100) designates a valve of end size NPS 6 (DN 150) with a port to match NPS 4 (DN 100). These valves shall have face-to-face or end-to-end dimensions corresponding to valves having the same size end connections; i.e., a NPS 6 × 4 (DN 150 × 100) valve shall have the face-to-face or end-to-end dimensions of a NPS 6 (DN 150) valve.

2.1.4 Reduced port, pressure seal bonnet, gate, globe, and check valves are designated for size by three numbers, the first and last being the NPS (DN) of the valve ends, the second being the NPS (DN) of the port; e.g., NPS 6 × 4 × 6 (DN 150 × 100 × 150) designates a valve having ends matching NPS 6 (DN 150) with a port to match NPS 4 (DN 100). Likewise, NPS 6 × 4 × 4 (DN 150 × 100 × 100) would designate a valve having one end matching NPS 6 (DN 150), the other matching NPS 4 (DN 100), and the port matching NPS 4 (DN 100). These valves shall have face-to-face or end-to-end dimensions corresponding to valves having the same port size; i.e., either a NPS 6 × 4 × 6 (DN 150 × 100 × 150) or a NPS 6 × 4 × 4 (DN 150 × 100 × 100) valve shall have the face-to-face or end-to-end dimensions of a NPS 4 (DN 100) valve.

2.2 Pressure Rating Designations

Valve class designations and related PN values are given below:

- (a) Cast iron

Class	PN
25	...
125	20
250	50

(b) Ductile iron

Class	PN
150	20
300	50

(c) Steel³

Class	PN
150	20
300	50
600	110
900	150
1500	260
2500	420

2.3 Flanged Valve Dimensions

2.3.1 Face-to-Face. The face-to-face dimension for flanged valves is the distance between the extreme ends which are the gasket contact surfaces (see Fig. 1). Face-to-face applies to flanged valves having the following nominal flange facing identifiers:

- (a) flat
- (b) 2 mm (0.06 in.) raised
- (c) 7 mm (0.25 in.) raised
- (d) large or small male⁴
- (e) large or small tongue⁴

2.3.2 Installed Face-to-Face. The installed face-to-face dimension of certain butterfly valves [see Table 8 (A8), Note (1)] may include allowances for gasket or resilient-facing compression. Refer to MSS SP-67 for definitive illustrations.

2.3.3 End-to-End. For those flanged valves where the gasket contact surfaces are not located at the extreme ends of the valve, the distance between the extreme ends is described as the end-to-end dimension and applies to flanged valves having the following nominal flange facing identifiers:

- (a) ring joint
- (b) large or small female
- (c) large or small groove

³ Includes all ferrous and nonferrous materials in ASME B16.34.

⁴ Face-to-face dimensions in Tables 1 to 6 (A1 to A6) must be adjusted as indicated in Table 9 (A9).

2.4 Buttwelding End Valve Dimensions (Also see Section 4)

For buttwelding end valves, the end-to-end dimension is the distance between the extreme ends (root faces) of the welding bevels (see Fig. 2).

2.5 Grooved End Valve Dimensions

The end-to-end dimension for grooved end valves is the distance between extreme ends.

2.6 Angle Valves

For flanged angle type valves (those in which the ends are at an angle of 90 deg to each other), the center-to-face dimension is the distance from the centerline of the port to the extreme end which is the gasket contact surface. For flanged angle type valves in which the gasket seating surface is not located at the extreme end and for angle type valves having buttwelding ends, the phrase center-to-end denotes the distance from the centerline of the port to the extreme end.

3 FACINGS OF FLANGED VALVES

Figure 1 shows facings for flanged ends.

3.1 Facings Normally Furnished

3.1.1 Flat Face. Flanges for Classes 25 and 125 cast iron valves are flat faced.

3.1.2 2 mm (0.06 in.) Raised Face. Flanges for Class 250 cast iron and for Classes 150 and 300 steel, alloy, and ductile iron valves have 2 mm (0.06 in.) raised faces, which are included in the face-to-face (or center-to-face) dimension. When Classes 150 and 300 valves are required with flat faces, either the full thickness of flange or the thickness with the 2 mm (0.06 in.) raised face removed may be furnished, unless otherwise specified by the customer. Users are reminded that removing the 2 mm (0.06 in.) raised face will make the face-to-face dimension nonstandard.

3.1.3 7 mm (0.25 in.) Raised Face. Flanges for Class 600 and higher steel and alloy valves have 7 mm (0.25 in.) raised faces, which are included in the face-to-face (or center-to-face) dimensions.

3.2 Other Standard Facings

Table 9 (A9) summarizes data on all flange facings and can be used with Tables 1 to 6 (A1 to A6) in calculating face-to-face and end-to-end dimensions of

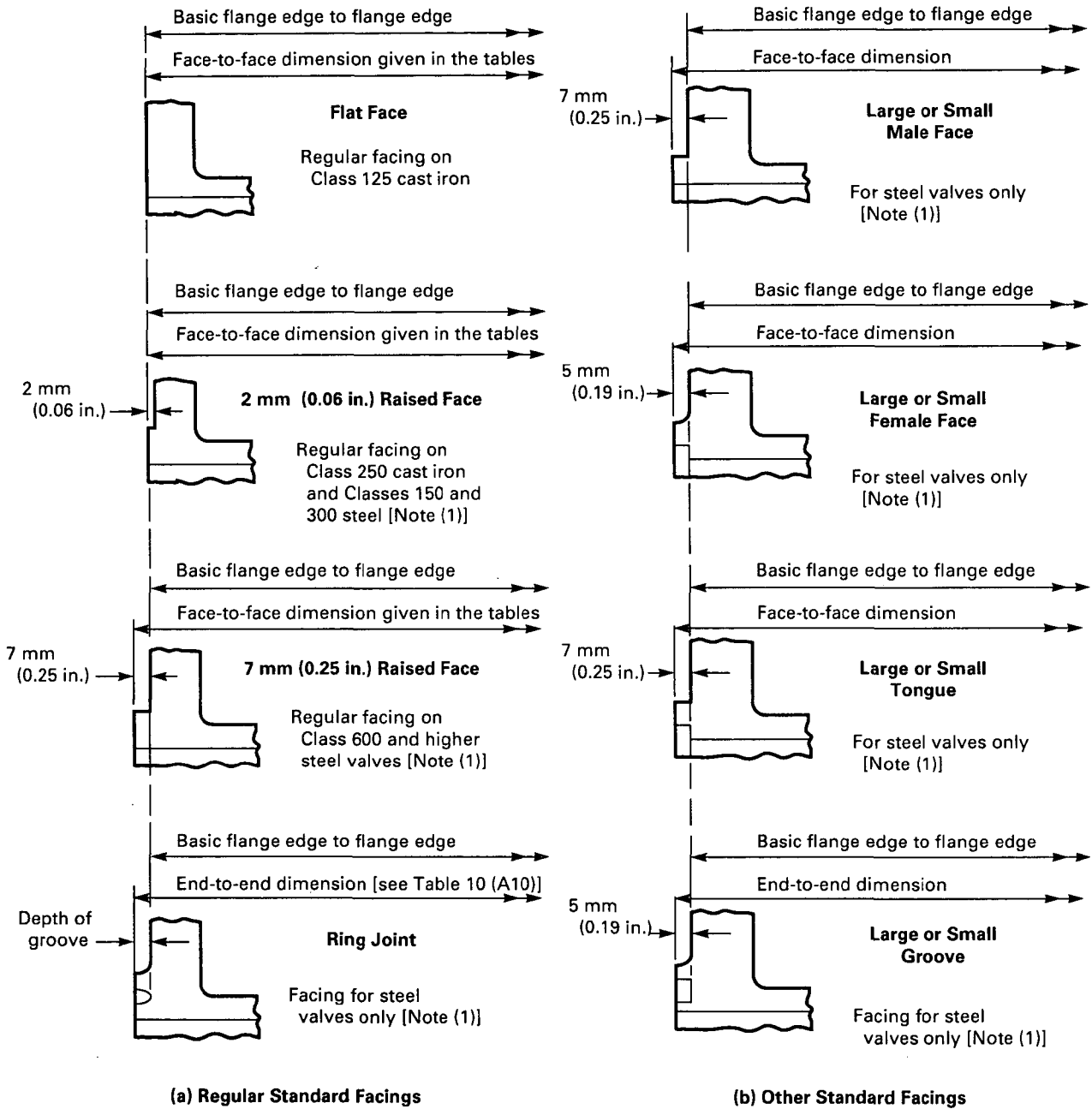

GENERAL NOTE:
Regular flange facings for valves are shown above. Valves normally carried in stock are so faced.

GENERAL NOTE:
Valves are supplied with the facings shown above when specified. See Table 9 (9A) to determine face-to-face dimensions of valves with these facings.

NOTE:
(1) Steel includes nonferrous materials in ASME B16.34.

FIG. 1 FLANGE FACINGS AND THEIR RELATIONSHIPS

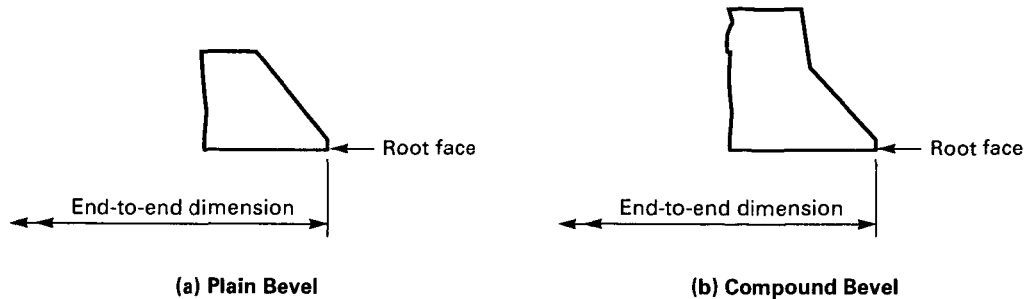

GENERAL NOTE:
Typical bevels are shown for illustration only.

FIG. 2 WELDING ENDS

flanged valves having standard facings other than those described in para. 3.1.

3.3 Ring Joint Facings

The *X* dimension given in Table 10 (A10), when added to the face-to-face dimension of a valve having raised face flanges in Tables 1 to 6 (A1 to A6), establishes the end-to-end dimension for the valve having flanges with ring joint facings.

4 VARIATIONS OF LENGTH WITHIN A CLASS OF VALVES

4.1 Buttwelding End Valves (Also see Para. 2.4)

Tables 1 to 6 (A1 to A6) include end-to-end dimensions for valves having buttwelding ends. In many cases, the dimensions are different from those of face-to-face dimensions of flanged valves, as evidenced by the differences between dimensions *A* and *B* of the tables.

4.1.1 Short Pattern. For pressure seal or flangeless bonnet valves having buttwelding ends in Class 600 and higher, the regular end-to-end dimensions shall be equal to the short pattern dimensions shown in Tables 3 to 6 (A3 to A6). At the manufacturer's option, the end-to-end dimensions of these valves may be the same as the face-to-face dimensions of raised face flanged valves.

4.1.2 Long Pattern. For flanged bonnet valves having buttwelding ends in Class 600 and higher, the regular end-to-end dimensions shall be equal to the

face-to-face dimensions of raised face flanged valves shown in Tables 3 to 6 (A3 to A6). At the manufacturer's option, the end-to-end dimensions may be the same as the short pattern end-to-end dimensions.

4.2 Narrow, Wide, and Extra Wide Designations

Certain butterfly valves are designated narrow, wide, or extra wide for the purpose of consolidating a diversity of manufacturer's lengths into two or three sets of dimensions for a given size. At the manufacturer's option, any of the two or three dimensions listed for a size may be used.

5 TOLERANCES

5.1 Straightway Valves

A tolerance of ± 2 mm (± 0.06 in.) shall be allowed on face-to-face and end-to-end dimensions of valves of NPS 10 (DN 250) and smaller, and a tolerance of ± 3 mm (± 0.12 in.) shall be allowed for NPS 12 (DN 300) and larger. For exceptions as related to wafer type and butterfly valves, see General Note (b) in Table 7 (A7) and Notes (4) and (5) in Table 8 (A8).

5.2 Angle Valves

The tolerances on center-to-face and center-to-end dimensions of angle type valves shall be one-half those listed in para. 5.1.

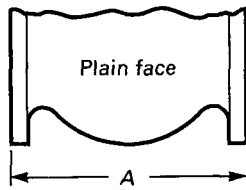

Class 125 Cast Iron

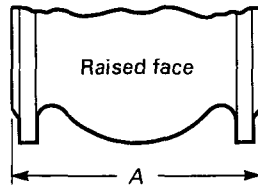

Class 150 Steel

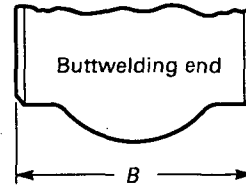

Class 150 Steel

TABLE 1 CLASS 125 CAST IRON FLANGED AND CLASS 150 STEEL FLANGED AND BUTTWELDING END VALVES, FACE-TO FACE AND END-TO-END DIMENSIONS

		1	2	3	4	5	6	7	8	9	10	
		Class 125 Cast Iron						Class 150 Steel				
		Flanged End (Flat Face)						Flanged End (2 mm Raised Face) and Welding End				
		Gate, Solid Wedge and Double Disc, A	Plug			Globe, Lift Check, and Swing Check [Note (1)], A	Angle and Lift Check, D	Gate			Plug Short Pattern, A	
			Short Pattern, A	Regular and Venturi Pattern, A	Round Port, Full Bore, A			Solid Wedge and Double Disc, A	Conduit, A	Solid Wedge, Double Disc, and Conduit, B		
NPS	DN											
1/4	8	102	...	102	...	
3/8	10	102	...	102	...	
1/2	15	108	...	108	...	
3/4	20	117	...	117	...	
1	25	...	140	140 (3)	140	127	...	127	140	
1 1/4	32	165 (3)	152	140	...	140	...	
1 1/2	40	...	165	165 (3)	165	165	...	165	165	
2	50	178	178	190 (3)	190	203	102	178	178	216	178	
2 1/2	65	190	190	210 (3)	210	216	108	190	190	241	190	
3	80	203	203	229 (3)	229	241	121	203	203	282	203	
4	100	229	229	229 (3)	305	292	146	229	229	305	229	
5	125	254	254	356 (3)	381	330	165	254	...	381	254	
6	150	267	267	394	457	356	178	267	267	403	267	
8	200	292	292	457	559	495	248	292	292	419	292	
10	250	330	330	533	660	622	311	330	330	457	330	
12	300	356	356	610	762	698	349	356	356	502	356	
14	350	381 (2)	...	686	...	787	394	381	381	572	...	
16	400	406 (2)	...	762	...	914 (5)	457	406	406	610	...	
18	450	432 (2)	...	864	432	432	660	...	
20	500	457 (2)	...	914	457	457	711	...	
22	550	508	762	...	
24	600	508 (2)	...	1067 (4)	508	508	813	...	
26	650	559	559	864 (6)	...	
28	700	610	610	914 (6)	...	
30	750	1295 (4)	610	660	914 (6)	...	
32	800	711	965 (6)	...	
34	850	762	1016 (6)	1016	
36	900	1600 (4)	711	813	1016 (6)	...	

(continued)

FACE-TO-FACE AND END-TO-END DIMENSIONS OF VALVES

ASME B16.10-2000

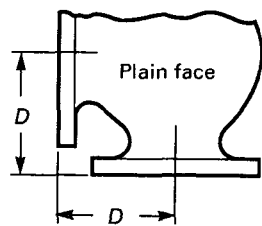

Class 125 Cast Iron

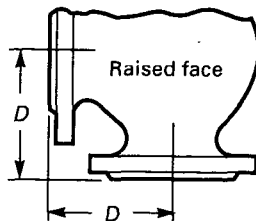

Class 150 Steel

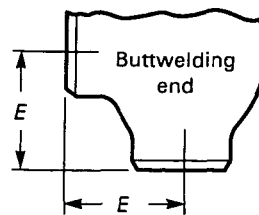

Class 150 Steel

TABLE 1 CLASS 125 CAST IRON FLANGED AND CLASS 150 STEEL FLANGED AND BUTTWELDING END VALVES, FACE-TO FACE AND END-TO-END DIMENSIONS (CONT'D)

		11	12	13	14	15	16	17	18	19	20	21
		Class 150 Steel										
		Flanged End (2 mm Raised Face) and Welding End							Flanged End		Welding End	
		Plug				Globe, Lift Check, and Swing Check [Note (1)], A and B	Angle and Lift Check, D and E	Y-Globe and Y-Swing Check, A and B	Ball			
		Regular Pattern, A	Short and Regular Pattern, B	Venturi Pattern, A	Round Port, Full Bore, A				Long Pattern, A	Short Pattern, A	Long Pattern, B	Short Pattern, B
Nominal Valve Size	NPS DN	A	B	A	A	A and B	D and E	A and B	A	A	B	B
1/4	8	102	51
3/8	10	102	51
1/2	15	108	57	140	108	108	...	140
3/4	20	117	64	152	117	117	...	152
1	25	176	127	70	165	127	127	...	165
1 1/4	32	140	76	184	140	140	...	178
1 1/2	40	222	165	83	203	165	165	190	190
2	50	...	267	178	267	203	102	229	178	178	216	216
2 1/2	65	...	305	...	298	216	108	279	190	190	241	241
3	80	...	330	203	343	241	121	318	203	203	282	282
4	100	305	356	229	432	292	146	368	229	229	305	305
5	125	381	381	356 (7)	178
6	150	394	457	394	...	406 (7)	203	470	394	267	457	403
8	200	457	521	457	...	495	248	597	457	292	521	419
10	250	533	559	533	...	622	311	673	533	330	559	457
12	300	610	635	610	...	698	349	775	610	356	635	502
14	350	686	...	686	...	787	394	...	686	381	762	572
16	400	762	...	762	...	914 (8)	457	...	762	406	838	610
18	450	864	...	864	...	978 (9)	864	...	914	660
20	500	914	...	914	...	978 (9)	914	...	991	711
22	550	1067 (9)	1092	...
24	600	1067	...	1067	...	1295 (9)	1067	...	1143	813
26	650	1295 (9)	1245	...
28	700	1448 (9)	1346	...
30	750	1524 (9)	1397	...
32	800	1524	...
34	850	1626	...
36	900	1956 (9)	1727	...

(continued)

TABLE 1 (CONT'D)**GENERAL NOTES:**

- (a) Dimensions are in millimeters.
- (b) See Table 9 for adjustments to tabulated dimensions which may be required for certain flange facings.

NOTES:

- (1) These dimensions are not intended to cover the type of check valve having the seat angle at approximately 45 deg to the run of the valve, or the "Underwriter Pattern," or other patterns where large clearances are required.
- (2) Solid wedge only.
- (3) Regular pattern only. The face-to-face dimension of NPS 4 (DN 100) may be 305 at the manufacturer's option.
- (4) Venturi pattern only.
- (5) Globe and horizontal lift check only.
- (6) Double disc and conduit only.
- (7) Globe and horizontal lift check only. The face-to-face and end-to-end dimension for class 150 steel flanged and buttwelding end swing check valves in NPS 5 (DN 125) is 330 and in NPS 6 (DN 150) is 356.
- (8) Globe and horizontal lift check only. The face-to-face and end-to-end dimension for class 150 steel flanged and buttwelding end swing check valves in NPS 16 (DN 400) is 864.
- (9) Swing check only.

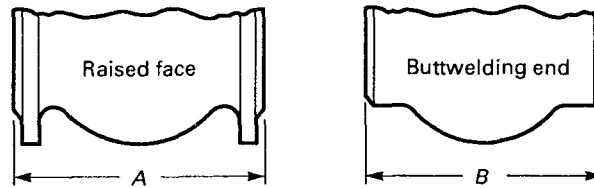

Class 250 Cast Iron
and Class 300 Steel

Class 300 Steel

TABLE 2 CLASS 250 CAST IRON FLANGED AND CLASS 300 STEEL FLANGED AND BUTTWELDING END VALVES, FACE-TO FACE AND END-TO-END DIMENSIONS

		1	2	3	4	5	6	7	8	9
		Class 250 Cast Iron						Class 300 Steel		
		Flanged End (2 mm Raised Face)						Flanged and Welding End		
		Gate, Solid Wedge and Double Disc, A	Plug			Globe, Lift Check, and Swing Check, A	Angle and Lift Check, D	Ball		
Nominal Valve Size	Short Pattern, A		Regular Pattern, A	Venturi Pattern, A	Long Pattern, A			Short Pattern, A and B	Long Pattern, B	
NPS	DN	A	A	A	A	A	D	A	A and B	B
1/2	15	140	140	...
3/4	20	152	152	...
1	25	159	165	165	...
1 1/4	32	178	178	...
1 1/2	40	190	190	190	190
2	50	216	184	216	...	267	133	216	216	216
2 1/2	65	241	203	241	...	292	146	241	241	241
3	80	282	235	282	...	318	159	282	282	282
4	100	305	267	305	...	356	178	305	305	305
5	125	381	...	387	...	400	200
6	150	403	378	425	403	444	222	403	403	457
8	200	419	...	502	419	533	267	502	419	521
10	250	457	568	597	457	622	311	568	457	559
12	300	502	648	711	502	711	356	648	502	635
14	350	572	762	762	572	762
16	400	610	838	838	610	838
18	450	660	914	914	660	914
20	500	711	991	991	711	991
22	550	1118	1092	...	1092
24	600	787	1143	1143	813	1143
26	650	1245	...	1245
28	700	1346	...	1346
30	750	1397	...	1397
32	800	1524	...	1524
34	850	1626	...	1626
36	900	1727	...	1727

(continued)

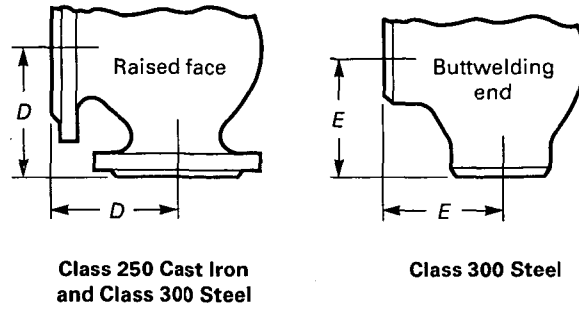

TABLE 2 CLASS 250 CAST IRON FLANGED AND CLASS 300 STEEL FLANGED AND BUTTWELDING END VALVES, FACE-TO FACE AND END-TO-END DIMENSIONS (CONT'D)

		10	11	12	13	14	15	16	17	
		Class 300 Steel								
		Flanged End (2 mm Raised Face) and Welding End								
Nominal Valve Size	NPS	DN	Gate, Solid Wedge, Double Disc, and Conduit, A and B	Plug				Globe and Lift Check, A and B	Angle and Lift Check, D and E	Swing Check, A and B
				Short and Venturi Pattern, A	Short and Venturi Pattern, B	Regular Pattern, A	Round Port, Full Bore, A and B			
1/2	15	140 (1)	152	76	...	
3/4	20	152 (1)	178	89	...	
1	25	165 (1)	159 (2)	203	102	216	
1 1/4	32	178 (1)	216	108	229	
1 1/2	40	190	190 (2)	229	114	241	
2	50	216	216	267 (2)	...	282	267	133	267	
2 1/2	65	241	241	305 (2)	...	330	292	146	292	
3	80	282	282	330 (2)	...	387	318	159	318	
4	100	305	305	356 (2)	...	457	356	178	356	
5	125	381	400	200	400	
6	150	403	403	457	403	559	444	222	444	
8	200	419	419	521	502	686	559	279	533	
10	250	457	457	559	568	826	622	311	622	
12	300	502	502	635	711	965	711	356	711	
14	350	762	762 (3)	762 (3)	762	838	
16	400	838	838 (3)	838 (3)	838	864	
18	450	914	914 (3)	914 (3)	914	978	
20	500	991	991 (3)	991 (3)	991	1016	
22	550	1092	1092 (3)	1092 (3)	1092	1118	
24	600	1143	1143 (3)	1143 (3)	1143	1346	
26	650	1245	1245 (3)	1245 (3)	1245	1346	
28	700	1346	1346 (3)	1346 (3)	1346	1499	
30	750	1397	1397 (3)	1397 (3)	1397	1594	
32	800	1524	1524 (3)	1524 (3)	1524	
34	850	1626	1626 (3)	1626 (3)	1626	
36	900	1727	1727 (3)	1727 (3)	1727	2083	

(continued)

TABLE 2 (CONT'D)

GENERAL NOTES:

- (a) Dimensions are in millimeters.
- (b) See Table 9 for adjustments to tabulated dimensions which may be required for certain flange facings.

NOTES:

- (1) Solid wedge only.
- (2) Plug—short pattern only.
- (3) Venturi pattern only.

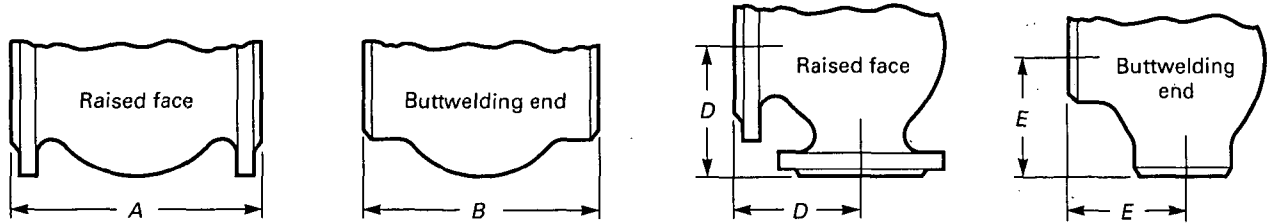

TABLE 3 CLASS 600 STEEL FLANGED AND BUTTWELDING END VALVES, FACE-TO FACE AND END-TO-END DIMENSIONS

		1	2	3	4	5	6	7	8	9	10
		Class 600 Steel									
		Flanged End (7 mm Raised Face and Welding End)									
Nominal Valve Size	NPS	DN	Ball	Gate		Plug		Globe Lift Check, and Swing Check, Long Pattern, A and B	Globe Lift Check, and Swing Check, Short Pattern [Note (1)], B	Angle and Lift Check, Long Pattern, D and E	Angle and Lift Check, Short Pattern [Note (1)], E
			Long Pattern, A and B	Solid Wedge, Double Disc, and Conduit, Long Pattern, A and B	Short Pattern, [Note (1)], B	Regular and Venturi Pattern, A and B	Round Bore, Full Port, A				
1/2	15	165	165 (2)	165	...	83	...
3/4	20	190	190 (2)	190	...	95	...
1	25	216	216	133	216 (4)	254	...	216	133	108	...
1 1/4	32	229	229	146	229 (4)	229	146	114	...
1 1/2	40	241	241	152	241	318	...	241	152	121	...
2	50	292	292	178	292	330	...	292	178	146	108
2 1/2	65	330	330	216	330	381	...	330	216	165	127
3	80	356	356	254	356	444	...	356	254	178	152
4	100	432	432	305	432	508	559	432	305	216	178
5	125	...	508	381	508	381	254	216
6	150	559	559	457	559	660	711	559	457	279	254
8	200	660	660	584	660	794	845	660	584	330	...
10	250	787	787	711	787	940	1016	787	711	394	...
12	300	838	838	813	838	1067	1067	838	813	419	...
14	350	889	889	889	889	889 (6)
16	400	991	991	991	991	991 (6)
18	450	1092	1092	1092	1092 (5)	1092 (6)
20	500	1194	1194	1194	1194 (5)	1194 (6)
22	550	1295	1295	...	1295 (5)	1295 (6)
24	600	1397	1397	1397	1397 (5)	1397 (6)
26	650	1448	1448	...	1448 (5)	1448 (6)
28	700	1549	1549	1600 (6)
30	750	1651	1651	...	1651 (5)	1651 (6)
32	800	1778	1778 (3)	...	1778 (5)
34	850	1930	1930 (3)	...	1930 (5)
36	900	2083	2083 (3)	...	2083 (5)	2083 (6)

(continued)

TABLE 3 (CONT'D)

GENERAL NOTES:

- (a) Dimensions are in millimeters.
- (b) See Table 9 for adjustments to tabulated dimensions which may be required for certain flange facings.

NOTES:

- (1) These dimensions apply to pressure seal or flangeless bonnet valves. They may be applied at the manufacturer's option to valves with flanged bonnets.
- (2) Solid wedge only.
- (3) Double disc and conduit only.
- (4) Regular pattern only.
- (5) Venturi pattern only.
- (6) Swing check only.

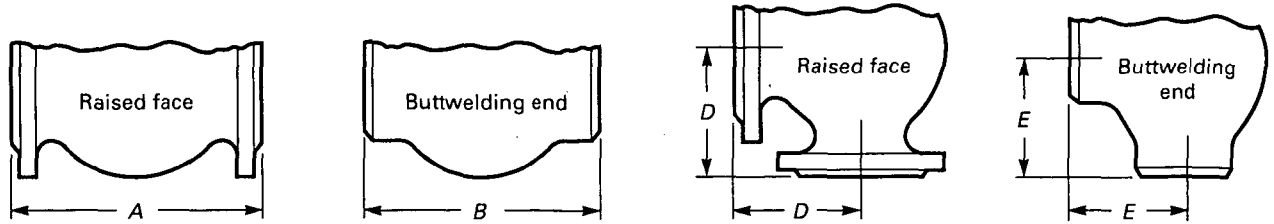

TABLE 4 CLASS 900 STEEL FLANGED AND BUTTWELDING END VALVES, FACE-TO FACE AND END-TO-END DIMENSIONS

		1	2	3	4	5	6	7	8	9
		Class 900 Steel								
		Flanged End (7 mm Raised Face) and Welding End								
		Gate		Plug		Globe Lift Check, and Swing Check, Long Pattern, A and B	Globe Lift Check, and Swing Check, Short Pattern [Note (1)], B	Angle and Lift Check, Long Pattern, D and E	Angle and Lift Check, Short Pattern [Note (1)], E	Ball
Nominal Valve Size		Solid Wedge, Double Disc, and Conduit, Long Pattern, A and B	Short Pattern, [Note (1)], B	Regular and Venturi Pattern, A and B	Round Port, Full Bore, A					Long Pattern, A and B
NPS	DN	A and B	B	A and B	A	A and B	B	D and E	E	A and B
3/4	20 (2)	229	...	114
1	25 (2)	254 (3)	140	254 (4)	...	254	...	127	...	254
1 1/4	32 (2)	279 (3)	165	279 (4)	...	279	...	140	...	279
1 1/2	40 (2)	305 (3)	178	305 (4)	356	305	...	152	...	305
2	50 (2)	368	216	368 (4)	381	368	...	184	...	368
2 1/2	65 (2)	419	254	419 (4)	432	419	254	210	...	419
3	80	381	305	381 (4)	470	381	305	190	152	381
4	100	457	356	457 (5)	559	457	356	229	178	457
5	125	559	432	559	432	279	216	...
6	150	610	508	610	737	610	508	305	254	610
8	200	737	660	737	813	737	660	368	330	737
10	250	838	787	838	965	838	787	419	394	838
12	300	965	914	965	1118	965	914	483	457	965
14	350	1029	991	1029	991	514	495	1029
16	400	1130	1092	1130 (5)	...	1130 (6)	1092	660	...	1130
18	450	1219	1219 (6)	...	737	...	1219
20	500	1321	...	1321 (5)	...	1321 (6)	...	826	...	1321
22	550
24	600	1549	1549 (6)	...	991	...	1549

GENERAL NOTES:

- (a) Dimensions are in millimeters.
- (b) See Table 9 for adjustments to tabulated dimensions which may be required for certain flange facings.

NOTES:

- (1) These dimensions apply to pressure seal or flangeless bonnet valves. They may be applied at the manufacturer's option to valves with flanged bonnets.
- (2) The connecting end flanges for class 900 valves, NPS 2 1/2 (DN 65) and smaller, are identical to those of class 1500 valves. The face-to-face dimensions for all class 900 valves, NPS 2 1/2 (DN 65) and smaller, except round port full bore plug valves (column 4), are identical with those of class 1500 valves.
- (3) Solid wedge only.
- (4) Regular pattern only.
- (5) Venturi pattern only.
- (6) Swing check only.

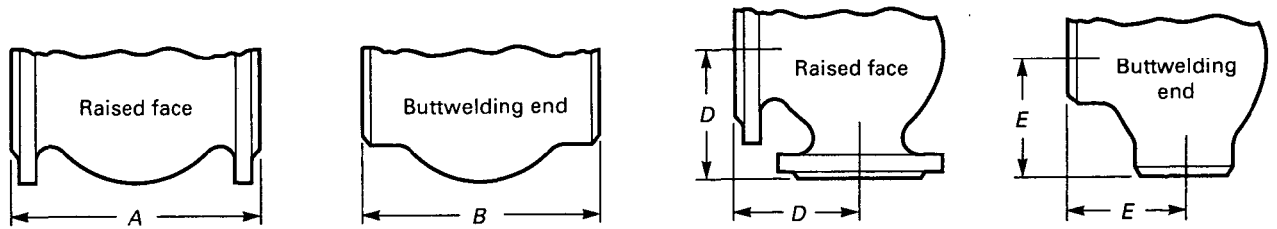

TABLE 5 CLASS 1500 STEEL FLANGED AND BUTTWELDING END VALVES, FACE-TO FACE AND END-TO-END DIMENSIONS

		1	2	3	4	5	6	7	8
		Class 1500 Steel							
		Flanged End (7 mm Raised Face) and Welding End							
		Gate		Plug		Globe Lift Check, and Swing Check, Long Pattern, A and B	Globe Lift Check, and Swing Check, Short Pattern [Note (1)], B	Angle and Lift Check, Long Pattern, D and E	Ball
Nominal Valve Size		Solid Wedge, Double Disc, and Conduit, Long Pattern, A and B	Short Pattern, [Note (1)], B	Regular and Venturi Pattern, A and B	Round Port, Full Bore, A				Long Pattern, A and B
NPS	DN								
1/2	15	216 (5)	...	108	...
3/4	20	229	...	114	...
1	25	254 (2)	140	254 (3)	...	254	...	127	...
1 1/4	32	279 (2)	165	279 (3)	...	279	...	140	...
1 1/2	40	305 (2)	178	305 (3)	...	305	...	152	...
2	50	368	216	368 (3)	391	368	216	184	368
2 1/2	65	419	254	419 (3)	454	419	254	210	419
3	80	470	305	470 (3)	524	470	305	235	470
4	100	546	406	546 (3)	625	546	406	273	546
5	125	673	483	673	483	337	...
6	150	705	559	705	787	705	559	353	705
8	200	832	711	832	889	832	711	416	832
10	250	991	864	991	1067	991	864	495	991
12	300	1130	991	1130	1219	1130	991	565	1130
14	350	1257	1067	1257	1067	629	1257
16	400	1384	1194	1384 (4)	...	1384 (6)	1194	...	1384
18	450	1537	1346	1537 (6)
20	500	1664	1473	1664 (6)
22	550
24	600	1943	1943 (6)

(continued)

TABLE 5 (CONT'D)

GENERAL NOTES:

- (a) Dimensions are in millimeters.
- (b) See Table 9 for adjustments to tabulated dimensions which may be required for certain flange facings.

NOTES:

- (1) These dimensions apply to pressure seal or flangeless bonnet valves. They may be applied at the manufacturer's option to valves with flanged bonnets.
- (2) Solid wedge only.
- (3) Regular pattern only.
- (4) Venturi pattern only.
- (5) Globe and lift check only.
- (6) Swing check only.

FACE-TO-FACE AND END-TO-END DIMENSIONS OF VALVES

ASME B16.10-2000

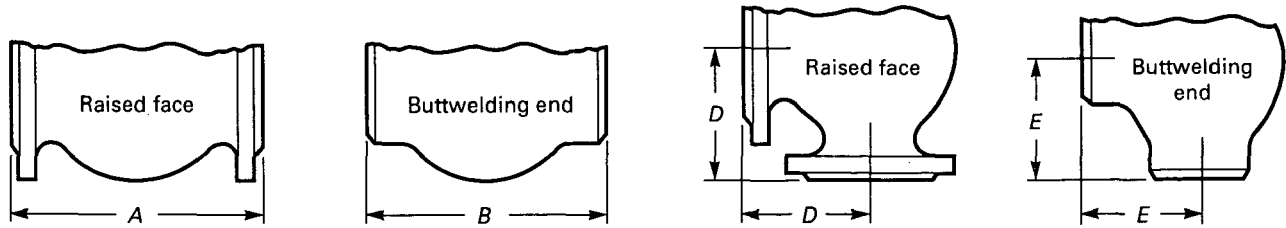

TABLE 6 CLASS 2500 STEEL FLANGED AND BUTTWELDING END VALVES, FACE-TO FACE AND END-TO-END DIMENSIONS

		1	2	3	4	5	6	7	
		Class 2500 Steel							
		Flanged End (7 mm Raised Face) and Welding End							
		Gate			Plug Regular Pattern, A and B	Globe Lift Check, and Swing Check, Long Pattern, A and B	Globe Lift Check, and Swing Check, Short Pattern [Note (1)], B	Angle and Lift Check, Long Pattern, D and E	Ball
Nominal Valve Size		Solid Wedge, Double Disc, and Conduit, Long Pattern, A and B	Short Pattern, [Note (1)], B	Long Pattern, A and B					Long Pattern, A and B
NPS	DN								
1/2	15	264 (2)	264	...	132	...	
3/4	20	273 (2)	273	...	137	...	
1	25	308 (2)	186	308	308	...	154	...	
1 1/4	32	349 (2)	232	...	349	...	175	...	
1 1/2	40	384 (2)	232	384	384	...	192	...	
2	50	451	279	451	451	279	226	451	
2 1/2	65	508	330	508	508	330	254	508	
3	80	578	368	578	578	368	289	578	
4	100	673	457	673	673	457	337	673	
5	125	794	533	794	794	533	397	...	
6	150	914	610	914	914	610	457	914	
8	200	1022	762	1022	1022	762	511	1022	
10	250	1270	914	1270	1270	914	635	1270	
12	300	1422	1041	1422	1422	1041	711	1422	
14	350	...	1118	
16	400	...	1245	
18	450	...	1397	

GENERAL NOTES:

(a) Dimensions are in millimeters.

(b) See Table 9 for adjustments to tabulated dimensions which may be required for certain flanged facings.

NOTES:

(1) These dimensions apply to pressure seal or flangeless bonnet valves. They may be applied at the manufacturer's option to valves with flanged bonnets.

(2) Solid wedge only.

TABLE 7 CLASS 125 AND 250 CAST IRON AND CLASSES 150 TO 2500 STEEL WAFER TYPE VALVES, FACE-TO-FACE DIMENSIONS

Nominal Valve Size	Swing Check, Single and Dual Plate, Installation Between Standard ANSI Flanges [Note (3)]															
	Steel [Note (1)]		Cast Iron [Note (2)]		Class						Class					
	Bonnet-less Knife Gate, Class 150 Flange Mating Dimensions		Swing Check, Single and Dual Plate, Installation Between Standard ANSI Flanges		Long Pattern [Note (4)]			Short Pattern [Note (5)]			Long Pattern [Note (4)]			Short Pattern [Note (5)]		
NPS	DN	1	2	3	4	5	6	7	8	9	10	11	12	13	14	
2	50	48	54	54	60	60	60	70	70	70	70	19	19	19	19	
2½	65	...	60	60	67	67	67	83	83	83	83	19	19	19	19	
3	80	51	67	67	73	73	73	83	83	86	86	19	19	19	22	
4	100	51	67	67	73	73	79	102	102	105	105	19	22	22	32	
5	125	57	83	83	
6	150	57	95	95	99	99	137	159	159	159	159	19	22	28	35	
8	200	70	127	127	127	127	165	206	206	206	206	28	28	38	44	
10	250	70	140	140	146	146	213	241	248	254	254	28	38	57	73	
12	300	76	181	181	181	181	229	292	305	305	305	38	51	60	...	
14	350	76	184	222	184	222	273	356	356	44	51	67	...	
16	400	89	190	232	190	232	305	384	384	51	51	73	...	
18	450	89	203	264	203	264	362	451	468	60	76	83	...	
20	500	114	213	292	219	292	368	451	533	64	83	92	...	
24	600	114	222	318	222	318	438	495	559	
30	750	...	305	368	305	368	505	
36	900	...	368	483	368	483	635	
42	1050	...	432	568	432	568	702	
48	1200	...	524	629	524	629	

GENERAL NOTES:

- (a) Dimensions are in millimeters.
- (b) The tolerances of para. 5.1 apply to face-to-face dimensions for sizes NPS 24 (DN 600) and smaller. For sizes NPS 30 (DN 750) and larger, the tolerance shall be ±6 mm.

NOTES:

- (1) These data for knife gate valves are extracted from TAPPI TIS 405-8 and MSS SP-81.
- (2) These data for cast iron swing check valves are extracted from API 594.
- (3) Valves of sizes NPS 30 (DN 750) and larger in class 150, 300, and 600 shall have body outside diameters and gasket surface dimensions compatible with flange standards specified in the purchase order, e.g., API 605 or MSS SP-44.
- (4) These data for long pattern steel swing check valves in sizes NPS 24 (DN 600) and smaller are extracted from API 594. Data for larger sizes are extracted from API 594.
- (5) These data for short pattern steel swing check valves are extracted from API 6D.

TABLE 8 CLASSES 25 AND 125 CAST IRON AND CLASSES 150 TO 600 STEEL BUTTERFLY VALVES, FACE-TO-FACE DIMENSIONS

Nominal Valve Size		1	2	3	4	5	6	7	8	9
		Class 150 Cast Iron and Steel [Notes (2), (3), and (4)]					Steel Grooved End [Notes (2), (4)]	Steel Offset Seat Lug and Wafer Style [Notes (5), (6)]		
		Flanged End		Lug and Wafer Style [Note (1)]				Class 150	Class 150	Class 300
NPS	DN	Narrow	Wide	Narrow	Wide	Extra Wide				
1½	40	33	37	38	86
2	50	43	44	46	81
2½	65	46	49	51	97
3	80	127	127	46	49	51	97	48	48	54
4	100	127	178	52	56	57	116	54	54	64
5	125	127	190	56	64	65	148
6	150	127	203	56	70	71	148	57	59	78
8	200	152	216	60	71	75	133	64	73	102
10	250	203	381	68	76	79	159	71	83	117
12	300	203	381	78	83	86	165	81	92	140
14	350	203	406	78	92	95	178	92	117	155
16	400	203	406	79	102	105	178	102	133	178
18	450	203	406	102	114	117	203	114	149	200
20	500	203	457	111	127	130	216	127	159	216
24	600	203	457	...	154	157	254	154	181	232
30	750	305	559	...	165
36	900	305	559	...	200
42	1050	305	610	...	251
48	1200	381	660	...	276
54	1350	381	711
60	1500	381	762
66	1650	457	864
72	1800	457	914

GENERAL NOTE: Dimensions are in millimeters.

NOTES:

- (1) The installed face-to-face dimension is the dimension of the valve face-to-face after installation in the pipeline. It does not include the thickness of gaskets where separate gaskets are used. It does include the compressed (installed) thickness of gaskets or seals that are an integral part of the valve.
- (2) These butterfly valves are of the design generally having concentric location of disc and seat, covered by MSS SP-67, from which these data are extracted.
- (3) These valves are dimensionally compatible with flanges conforming to ASME B16.1 Class 25 or Class 125, ASME B16.5 Class 150, ASME B16.24 Class 150, ASME B16.42 Class 150, or AWWA C-207.
- (4) For these butterfly valves, a tolerance of +/- 2 mm shall be allowed on face-to-face dimensions of valves of NPS 6 (DN 150) and smaller, and a tolerance of +/- 3 mm on NPS 8 (DN 200) and larger, except that for single flange and flangeless valves of NPS 30 (DN 750) and larger, a tolerance of +/- 6 mm shall be allowed.
- (5) For these valves, a tolerance of +/- 3 mm shall be allowed on the face-to-face dimensions for all sizes and pressure classes.
- (6) The data for offset seat valves, columns 7-9, are extracted from MSS SP-68 and API 609 [except NPS 16-NPS 24 (DN 400- DN 600) Class 600, which are only in MSS SP-68].

TABLE 9 DETERMINATION OF FACE-TO-FACE AND END-TO-END DIMENSIONS OF FLANGED VALVES HAVING VARIOUS FLANGE FACINGS

Material	Class	Flat Face	Face-to-Face [Notes (1) and (2)]				Ring Type Joint	Large or Small	
			2 mm Raised Face	7 mm Raised Face	Large or Small			Female Face	Groove Face
					Male Face	Tongue Face			
Cast Iron	125	(3)	
	250	...	(3)	
Steel	125	(4)	(3)	...	+ 13	+ 13	(6)	+ 10	+ 10
	300	(4)	(3)	...	+ 13	+ 13	(6)	+ 10	+ 10
	600 to 2500	(3)	(5)	(5)	(6)	- 3	- 3

GENERAL NOTE: Dimensions are in millimeters.

NOTES:

- (1) To determine the face-to-face or end-to-end dimensions of valves having both flanges as tabulated in this table, adjust the face-to-face (not the butt-weld end-to-end) dimensions shown for the valve type (gate, globe, etc.), material, class, and size in Tables 1 to 6 by the amount shown.
- (2) For center-to-face or center-to-end dimensions of angle type valves, use one-half the numerical adjustment shown herein.
- (3) These face-to-face dimensions are listed in Tables 1 to 6. (See table of desired Class Number.)
- (4) For Class 150 and for Class 300 steel valves having flat faces, either the full thickness of the flange or the thickness with the 2 mm raised face removed may be supplied unless otherwise specified. For full thickness of flange, the face-to-face dimensions listed for 2 mm raised face apply. Users are reminded that removing the 2 mm raised faces will make the face-to-face dimensions nonstandard.
- (5) These face-to-face dimensions are those listed for 7 mm raised face in Tables 3 to 6.
- (6) The X dimensions given in Table 10 added to the appropriate raised face flange face-to-face dimensions of Tables 1 to 6 establish the end-to-end dimensions of steel valves having flanges with ring joint facings.

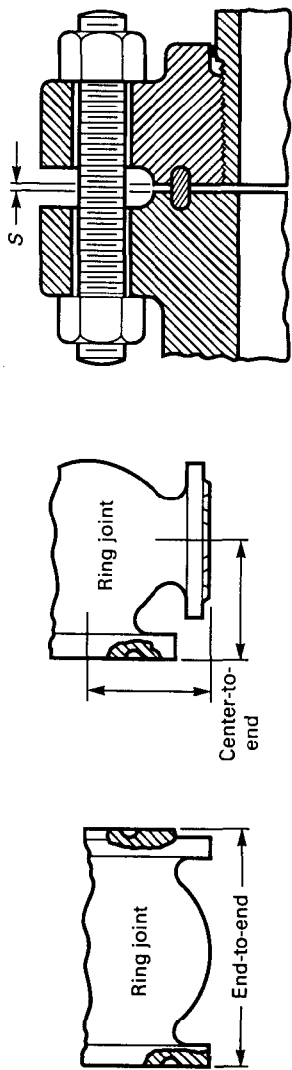

TABLE 10 CLASSES 150 TO 2500 STEEL VALVES HAVING END FLANGES WITH RING JOINT FACINGS, END-TO-END DIMENSIONS

Nominal Valve Size	Class 150		Class 300		Class 600		Class 900		Class 1500		Class 2500		
	1	2	3	4	5	6	7	8	9	10	11	12	
NPS	DN	X	S	X	S	X	S	X	S	X	S	X	S
1/2	15	11	3	-2 (3)	3	0	4	0	4	0	4
3/4	20	13	4	0	4	0	4	0	4	0	4
1	25	13	4	13	4	0	4	0	4	0	4	0	4
1 1/4	32	13	4	13	4	0	4	0	4	0	4	0	4
1 1/2	40	13	4	13	4	0	4	0	4	0	4	0	4
2	50	13	4	16	6	3	5	3	3	3	3	3	3
2 1/2	65	13	4	16	6	3	5	3	3	3	3	3	3
3	80	13	4	16	6	3	5	3	3	3	3	3	3
4	100	13	4	16	6	3	5	3	3	3	3	3	3
5	125	13	4	16	6	3	5	3	3	3	3	3	3
6	150	13	4	16	6	3	5	3	3	3	3	3	3
8	200	13	4	16	6	3	5	3	3	3	3	3	3
10	250	13	4	16	6	3	5	3	3	3	3	3	3
12	300	13	4	16	6	3	5	3	3	3	3	3	3
14	350	13	3	16	6	3	5	3	3	3	3	3	3
16	400	13	3	16	6	3	5	3	3	3	3	3	3
18	450	13	3	16	6	3	5	3	3	3	3	3	3
20	500	13	3	19	6	3	5	3	3	3	3	3	3
22	550	13 (1)	(2)	22 (1)	6	10 (1)	6
24	600	13	3	22	6	10	6	19	6	28	11

(continued)

TABLE 10 CLASSES 150 TO 2500 STEEL VALVES HAVING END FLANGES WITH RING JOINT FACINGS, END-TO-END DIMENSIONS (CONT'D)

Nominal Valve Size	Dimensions (mm)																								
	1		2		3		4		5		6		7		8		9		10		11		12		
	Class 150		Class 300		Class 600		Class 900		Class 1500		Class 2500		Class 1500		Class 900		Class 600		Class 300		Class 150		Class 150		
NPS	DN	X	S	X	S	X	S	X	S	X	S	X	S	X	S	X	S	X	S	X	S	X	S	X	S
26	650	25 (1)	6	13 (1)	6
28	700	25 (1)	6	13 (1)	6
30	750	25 (1)	6	13 (1)	6
32	800	28 (1)	(2)	16 (1)	(2)
34	850	28 (1)	(2)	16 (1)	(2)
36	900	28 (1)	(2)	16 (1)	(2)

GENERAL NOTES:

- (a) Dimensions are in millimeters.
- (b) Flanges conform to those of ASME B16.5 for the corresponding size and pressure class, except in NPS 22 (DN 550), NPS 26 (DN 650), and larger sizes. See Note (1).
- (c) To determine the end-to-end dimensions of valves having flanges with ring joint facings, the X dimensions must be added to the nominal raised face face-to-face dimensions of Tables 1 to 6. For angle and angle lift check valves, one-half of the X dimensions as listed in this table must be added to the nominal dimensions for center-to-end dimensions. For approximate distance between ends of flanges having octagonal or oval ring gaskets, when rings are compressed, use S dimensions as listed in this table.

NOTES:

- (1) Flanges for NPS 22 (DN 550), NPS 26 (DN 650), and larger sizes conform to those of MSS SP-44 and ASME B16.47, Series A for the corresponding size and pressure class.
- (2) S dimension is not determined.
- (3) This dimension has a minus value because the height of the applicable ring joint face is 1 mm less than the height of the raised face.

FACE-TO-FACE AND END-TO-END DIMENSIONS OF VALVES

ASME B16.10-2000

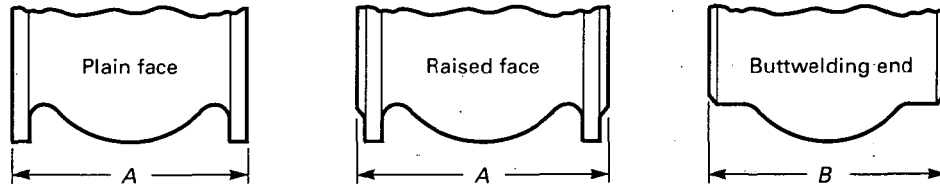

Class 125 Cast Iron

Class 150 Steel

Class 150 Steel

TABLE A1 CLASS 125 CAST IRON FLANGED AND CLASS 150 STEEL FLANGED AND BUTTWELDING END VALVES, FACE-TO-FACE AND END-TO-END DIMENSIONS

		1	2	3	4	5	6	7	8	9	10	
		Class 125 Cast Iron						Class 150 Steel				
		Flanged End (Flat Face)						Flanged End (0.06 in. Raised Face) and Welding End				
		Gate, Solid Wedge and Double Disc, A	Plug			Globe, Lift Check, and Swing Check [Note (1)], A	Angle and Lift Check, D	Gate			Plug	
			Short Pattern, A	Regular and Venturi Pattern, A	Round Port, Full Bore, A			Solid Wedge and Double Disc, A	Conduit, A	Solid Wedge, Double Disc, and Conduit, B		Short Pattern, A
NPS	DN											
1/4	8	4.00	...	4.00	...	
3/8	10	4.00	...	4.00	...	
1/2	15	4.25	...	4.25	...	
3/4	20	4.62	...	4.62	...	
1	25	...	5.50	5.50 (3)	5.50	5.00	...	5.00	5.50	
1 1/4	32	6.50 (3)	6.00	5.50	...	5.50	...	
1 1/2	40	...	6.50	6.50 (3)	6.50	6.50	...	6.50	6.50	
2	50	7.00	7.00	7.50 (3)	7.50	8.00	4.00	7.00	7.00	8.50	7.00	
2 1/2	65	7.50	7.50	8.25 (3)	8.25	8.50	4.25	7.50	7.50	9.50	7.50	
3	80	8.00	8.00	9.00 (3)	9.00	9.50	4.75	8.00	8.00	11.12	8.00	
4	100	9.00	9.00	9.00 (3)	12.00	11.50	5.75	9.00	9.00	12.00	9.00	
5	125	10.00	10.00	14.00 (3)	15.00	13.00	6.50	10.00	...	15.00	10.00	
6	150	10.50	10.50	15.50	18.00	14.00	7.00	10.50	10.50	15.88	10.50	
8	200	11.50	11.50	18.00	22.00	19.50	9.75	11.50	11.50	16.50	11.50	
10	250	13.00	13.00	21.00	26.00	24.50	12.25	13.00	13.00	18.00	13.00	
12	300	14.00	14.00	24.00	30.00	27.50	13.75	14.00	14.00	19.75	14.00	
14	350	15.00 (2)	...	27.00	...	31.00	15.50	15.00	15.00	22.50	...	
16	400	16.00 (2)	...	30.00	...	36.00 (5)	18.00	16.00	16.00	24.00	...	
18	450	17.00 (2)	...	34.00	17.00	17.00	26.00	...	
20	500	18.00 (2)	...	36.00	18.00	18.00	28.00	...	
22	550	20.00	30.00	...	
24	600	20.00 (2)	...	42.00 (4)	20.00	20.00	32.00	...	
26	650	22.00	22.00	34.00 (6)	...	
28	700	24.00	24.00	36.00 (6)	...	
30	750	51.00 (4)	24.00	26.00	36.00 (6)	...	
32	800	28.00	38.00 (6)	...	
34	850	30.00	40.00 (6)	40.00	
36	900	63.00 (4)	28.00	32.00	40.00 (6)	...	

(continued)

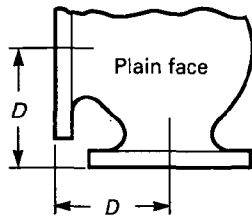

Class 125 Cast Iron

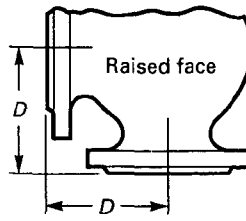

Class 150 Steel

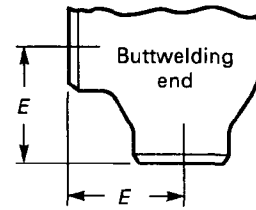

Class 150 Steel

TABLE A1 CLASS 125 CAST IRON FLANGED AND CLASS 150 STEEL FLANGED AND BUTTWELDING END VALVES, FACE-TO-FACE AND END-TO-END DIMENSIONS (CONT'D)

		11	12	13	14	15	16	17	18	19	20	21
		Class 150 Steel										
		Flanged End (0.06 in. Raised Face) and Welding End							Flanged End		Welding End	
		Plug				Globe, Lift Check, and Swing Check [Note (1)], A and B	Angle and Lift Check, D and E	Y-Globe and Y-Swing Check, A and B	Ball			
		Regular Pattern, A	Short and Regular Pattern, B	Venturi Pattern, A	Round Port, Full Bore, A				Long Pattern, A	Short Pattern, A	Long Pattern, B	Short Pattern, B
Nominal Valve Size												
NPS	DN											
1/4	8	4.00	2.00
3/8	10	4.00	2.00
1/2	15	4.25	2.25	5.50	4.25	4.25	...	5.50
3/4	20	4.62	2.50	6.00	4.62	4.62	...	6.00
1	25	7.00	5.00	2.75	6.50	5.00	5.00	...	6.50
1 1/4	32	5.50	3.00	7.25	5.50	5.50	...	7.00
1 1/2	40	8.75	6.50	3.25	8.00	6.50	6.50	7.50	7.50
2	50	...	10.50	7.00	10.50	8.00	4.00	9.00	7.00	7.00	8.50	8.50
2 1/2	65	...	12.00	...	11.75	8.50	4.25	11.00	7.50	7.50	9.50	9.50
3	80	...	13.00	8.00	13.50	9.50	4.75	12.50	8.00	8.00	11.12	11.12
4	100	12.00	14.00	9.00	17.00	11.50	5.75	14.50	9.00	9.00	12.00	12.00
5	125	15.00	15.00	14.00 (7)	7.00
6	150	15.50	18.00	15.50	...	16.00 (7)	8.00	18.50	15.50	10.50	18.00	15.88
8	200	18.00	20.50	18.00	...	19.50	9.75	23.50	18.00	11.50	20.50	16.50
10	250	21.00	22.00	21.00	...	24.50	12.25	26.50	21.00	13.00	22.00	18.00
12	300	24.00	25.00	24.00	...	27.50	13.75	30.50	24.00	14.00	25.00	19.75
14	350	27.00	...	27.00	...	21.00	15.50	...	27.00	15.00	30.00	22.50
16	400	30.00	...	30.00	...	36.00 (8)	18.00	...	30.00	16.00	33.00	24.00
18	450	34.00	...	34.00	...	38.50 (9)	34.00	...	36.00	26.00
20	500	36.00	...	36.00	...	38.50 (9)	36.00	...	39.00	28.00
22	550	42.00 (9)	43.00	...
24	600	42.00	...	42.00	...	51.00 (9)	42.00	...	45.00	32.00
26	650	51.00 (9)	49.00	...
28	700	57.00 (9)	53.00	...
30	750	60.00 (9)	55.00	...
32	800	60.00	...
34	850	64.00	...
36	900	77.00 (9)	68.00	...

(continued)

TABLE A1 (CONT'D)

GENERAL NOTES:

- (a) Dimensions are in inches.
- (b) See Table A9 for adjustments to tabulated dimensions which may be required for certain flange facings.

NOTES:

- (1) These dimensions are not intended to cover the type of check valve having the seat angle at approximately 45 deg to the run of the valve, or the "Underwriter Pattern," or other patterns where large clearances are required.
- (2) Solid wedge only.
- (3) Regular pattern only. The face-to-face dimension of NPS 4 may be 12.00 at the manufacturer's option.
- (4) Venturi pattern only.
- (5) Globe and horizontal lift check only.
- (6) Double disc and conduit only.
- (7) Globe and horizontal lift check only. The face-to-face and end-to-end dimension for Class 150 steel flanged and buttwelding end swing check valves in NPS 5 is 13.00 and in NPS 6 is 14.00.
- (8) Globe and horizontal lift check only. The face-to-face and end-to-end dimension for Class 150 steel flanged and buttwelding end swing check valves in NPS 16 is 34.00
- (9) Swing check only.

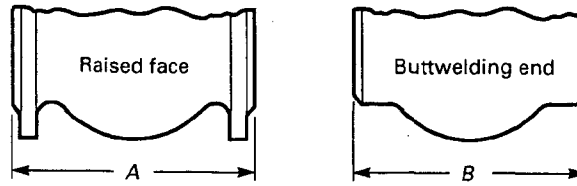

Class 250 Cast Iron and Class 300 Steel

Class 300 Steel

TABLE A2 CLASS 250 CAST IRON FLANGED AND CLASS 300 STEEL FLANGED AND BUTTWELDING END VALVES, FACE-TO-FACE AND END-TO-END DIMENSIONS

Nominal Valve Size NPS DN		1	2	3	4	5	6	7	8	9	
		Class 250 Cast Iron						Class 300 Steel			
		Flanged End (0.06 in. Raised Face)						Flanged and Welding End			
		Gate, Solid Wedge and Double Disc, A	Plug			Globe, Lift Check, and Swing Check, A	Angle and Lift Check, D	Ball			
Short Pattern, A	Regular Pattern, A		Venturi Pattern, A	Long Pattern, A	Short Pattern, A and B			Long Pattern, B			
1/2	15	5.50	5.50	...	
3/4	20	6.00	6.00	...	
1	25	6.25	6.50	6.50	...	
1 1/4	32	7.00	7.00	...	
1 1/2	40	7.50	7.50	7.50	7.50	
2	50	8.50	7.25	8.50	...	10.50	5.25	8.50	8.50	8.50	
2 1/2	65	9.50	8.00	9.50	...	11.50	5.75	9.50	9.50	9.50	
3	80	11.12	9.25	11.12	...	12.50	6.25	11.12	11.12	11.12	
4	100	12.00	10.50	12.00	...	14.00	7.00	12.00	12.00	12.00	
5	125	15.00	...	15.25	...	15.75	7.88	
6	150	15.88	14.88	16.75	15.88	17.50	8.75	15.88	15.88	18.00	
8	200	16.50	...	19.75	16.50	21.00	10.50	19.75	16.50	20.50	
10	250	18.00	22.38	23.50	18.00	24.50	12.25	22.38	18.00	22.00	
12	300	19.75	25.50	28.00	19.75	28.00	14.00	25.50	19.75	25.00	
14	350	22.50	30.00	30.00	22.50	30.00	
16	400	24.00	33.00	33.00	24.00	33.00	
18	450	26.00	36.00	36.00	26.00	36.00	
20	500	28.00	39.00	39.00	28.00	39.00	
22	550	44.00	43.00	...	43.00	
24	600	31.00	45.00	45.00	32.00	45.00	
26	650	49.00	...	49.00	
28	700	53.00	...	53.00	
30	750	55.00	...	55.00	
32	800	60.00	...	60.00	
34	850	64.00	...	64.00	
36	900	68.00	...	68.00	

(continued)

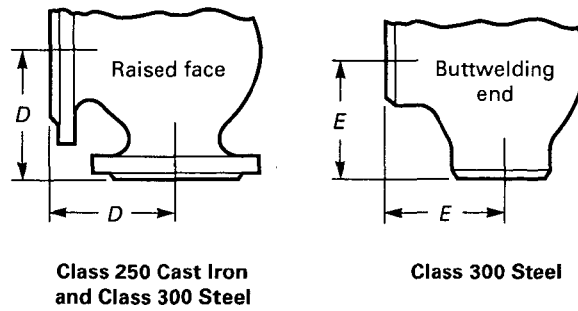

TABLE A2 CLASS 250 CAST IRON FLANGED AND CLASS 300 STEEL FLANGED AND BUTTWELDING END VALVES, FACE-TO-FACE AND END-TO-END DIMENSIONS (CONT'D)

Nominal Valve Size NPS DN		10	11	12	13	14	15	16	17	
		Class 300 Steel								
		Flanged End (0.06 in. Raised Face) and Welding End								
		Gate, Solid Wedge, Double Disc, and Conduit, A and B	Plug				Globe and Lift Check, A and B	Angle and Lift Check, D and E	Swing Check, A and B	
Short and Venturi Pattern, A	Short and Venturi Pattern, B		Regular Pattern, A	Round Port, Full Bore, A and B						
1/2	15	5.50 (1)	6.00	3.00	...	
3/4	20	6.00 (1)	7.00	3.50	...	
1	25	6.50 (1)	6.25 (2)	7.50	8.00	4.00	8.50	
1 1/4	32	7.00 (1)	8.50	4.25	9.00	
1 1/2	40	7.50	7.50 (2)	9.50	9.00	4.50	9.50	
2	50	8.50	8.50	10.50 (2)	...	11.12	10.50	5.25	10.50	
2 1/2	65	9.50	9.50	12.00 (2)	...	13.00	11.50	5.75	11.50	
3	80	11.12	11.12	13.00 (2)	...	15.25	12.50	6.25	12.50	
4	100	12.00	12.00	14.00 (2)	...	18.00	14.00	7.00	14.00	
5	125	15.00	15.75	7.88	15.75	
6	150	15.88	15.88	18.00	15.88	22.00	17.50	8.75	17.50	
8	200	16.50	16.50	20.50	19.75	27.00	22.00	11.00	21.00	
10	250	18.00	18.00	22.00	22.38	32.50	24.50	12.25	24.50	
12	300	19.75	19.75	25.00	28.00	38.00	28.00	14.00	28.00	
14	350	30.00	30.00 (3)	30.00 (3)	30.00	33.00	
16	400	33.00	33.00 (3)	33.00 (3)	33.00	34.00	
18	450	36.00	36.00 (3)	36.00 (3)	36.00	38.50	
20	500	39.00	39.00 (3)	39.00 (3)	39.00	40.00	
22	550	43.00	43.00 (3)	43.00 (3)	43.00	44.00	
24	600	45.00	45.00 (3)	45.00 (3)	45.00	53.00	
26	650	49.00	49.00 (3)	49.00 (3)	49.00	53.00	
28	700	53.00	53.00 (3)	53.00 (3)	53.00	59.00	
30	750	55.00	55.00 (3)	55.00 (3)	55.00	62.75	
32	800	60.00	60.00 (3)	60.00 (3)	60.00	
34	850	64.00	64.00 (3)	64.00 (3)	64.00	
36	900	68.00	68.00 (3)	68.00 (3)	68.00	82.00	

(continued)

TABLE A2 (CONT'D)

GENERAL NOTES:

- (a) Dimensions are in inches.
- (b) See Table A9 for adjustments to tabulated dimensions which may be required for certain flange facings.

NOTES:

- (1) Solid wedge only.
- (2) Plug—short pattern only.
- (3) Venturi pattern only.

FACE-TO-FACE AND END-TO-END DIMENSIONS OF VALVES

ASME B16.10-2000

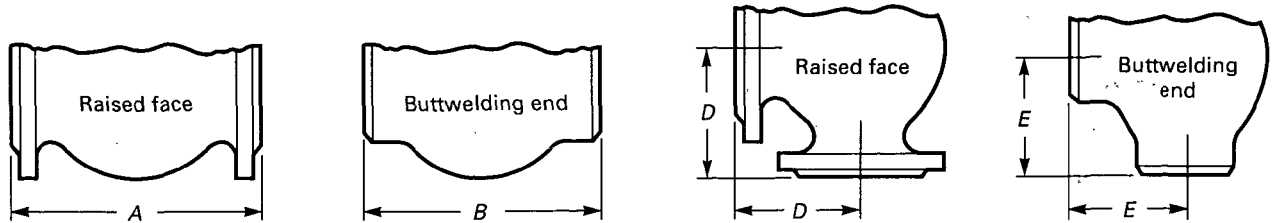

TABLE A3 CLASS 600 STEEL FLANGED AND BUTTWELDING END VALVES, FACE-TO-FACE AND END-TO-END DIMENSIONS

		1	2	3	4	5	6	7	8	9	10
Class 600 Steel											
Flanged End (0.25 in. Raised Face) and Welding End											
Nominal Valve Size		Ball	Gate		Plug			Globe, Lift Check, and Swing Check, Long Pattern, A and B	Globe, Lift Check, and Swing Check, Short Pattern [Note (1)], B	Angle and Lift Check, Long Pattern, D and E	Angle and Lift Check, Short Pattern [Note (1)] E
		Long Pattern, A and B	Solid Wedge, Double Disc, and Conduit, Long Pattern, A and B	Short Pattern [Note (1)], B	Regular and Venturi Pattern, A and B	Round Bore, Full Port, A	Round Bore, Full Port, B				
NPS	DN	A and B	A and B	B	A and B	A	B	A and B	B	D and E	E
1/2	15	6.50	6.50 (2)	6.50	...	3.25	...
3/4	20	7.50	7.50 (2)	7.50	...	3.75	...
1	25	8.50	8.50	5.25	8.50 (4)	10.00	...	8.50	5.25	4.25	...
1 1/4	32	9.00	9.00	5.75	9.00 (4)	9.00	5.75	4.50	...
1 1/2	40	9.50	9.50	6.00	9.50	12.50	...	9.50	6.00	4.75	...
2	50	11.50	11.50	7.00	11.50	13.00	...	11.50	7.00	5.75	4.25
2 1/2	65	13.00	13.00	8.50	13.00	15.00	...	13.00	8.50	6.50	5.00
3	80	14.00	14.00	10.00	14.00	17.50	...	14.00	10.00	7.00	6.00
4	100	17.00	17.00	12.00	17.00	20.00	22.00	17.00	12.00	8.50	7.00
5	125	...	20.00	15.00	20.00	15.00	10.00	8.50
6	150	22.00	22.00	18.00	22.00	26.00	28.00	22.00	18.00	11.00	10.00
8	200	26.00	26.00	23.00	26.00	31.25	33.25	26.00	23.00	13.00	...
10	250	31.00	31.00	28.00	31.00	37.00	40.00	31.00	28.00	15.50	...
12	300	33.00	33.00	32.00	33.00	42.00	42.00	33.00 (6)	32.00	16.50	...
14	350	35.00	35.00	35.00	35.00	35.00 (6)
16	400	39.00	39.00	39.00	39.00	39.00 (6)
18	450	43.00	43.00	43.00	43.00 (5)	43.00 (6)
20	500	47.00	47.00	47.00	47.00 (5)	47.00 (6)
22	550	51.00	51.00	...	51.00 (5)	51.00 (6)
24	600	55.00	55.00	55.00	55.00 (5)	55.00 (6)
26	650	57.00	57.00	...	57.00 (5)	57.00 (6)
28	700	61.00	61.00	63.00 (6)
30	750	65.00	65.00	...	65.00 (5)	65.00 (6)
32	800	70.00	70.00 (3)	...	70.00 (5)
34	850	76.00	76.00 (3)	...	76.00 (5)
36	900	82.00	82.00 (3)	...	82.00 (5)	82.00 (6)

(continued)

TABLE A3 (CONT'D)

GENERAL NOTES:

- (a) Dimensions are in inches.
- (b) See Table A9 for adjustments to tabulated dimensions which may be required for certain flange facings.

NOTES:

- (1) These dimensions apply to pressure seal or flangeless bonnet valves. They may be applied at the manufacturer's option to valves with flanged bonnets.
- (2) Solid wedge only.
- (3) Double disc and conduit only.
- (4) Regular pattern only.
- (5) Venturi pattern only.
- (6) Swing check only.

FACE-TO-FACE AND END-TO-END DIMENSIONS OF VALVES

ASME B16.10-2000

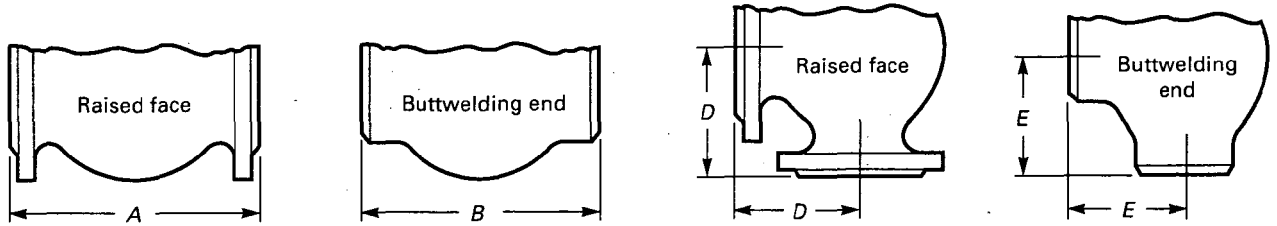

TABLE A4 CLASS 900 STEEL FLANGED AND BUTTWELDING END VALVES, FACE-TO-FACE AND END-TO-END DIMENSIONS

		1	2	3	4	5	6	7	8	9
		Class 900 Steel Valves								
		Flanged End (0.25 in. Raised Face) and Welding End								
		Gate		Plug		Globe, Lift Check, and Swing Check, Long Pattern, A and B	Globe, Lift Check, and Swing Check, Short Pattern [Note (1)], B	Angle and Lift Check, Long Pattern, D and E	Angle and Lift Check, Short Pattern [Note (1)] E	Ball
Nominal Valve Size		Solid Wedge, Double Disc, and Conduit, Long Pattern, A and B	Short Pattern [Note (1)], B	Regular and Venturi Pattern, A and B	Round Port, Full Bore, A					Long Pattern, A and B
NPS	DN	A and B	B	A and B	A	A and B	B	D and E	E	A and B
3/4 (2)	20 (2)	9.00	...	4.50
1 (2)	25 (2)	10.00 (3)	5.50	10.00 (4)	...	10.00	...	5.00	...	10.00
1 1/4 (2)	32 (2)	11.00 (3)	6.50	11.00 (4)	...	11.00	...	5.50	...	11.00
1 1/2 (2)	40 (2)	12.00 (3)	7.00	12.00 (4)	14.00	12.00	...	6.00	...	12.00
2 (2)	50 (2)	14.50	8.50	14.50 (4)	15.00	14.50	...	7.25	...	14.50
2 1/2 (2)	65 (2)	16.50	10.00	16.50 (4)	17.00	16.50	10.00	8.25	...	16.50
3	80	15.00	12.00	15.00 (4)	18.50	15.00	12.00	7.50	6.00	15.00
4	100	18.00	14.00	18.00 (5)	22.00	18.00	14.00	9.00	7.00	18.00
5	125	22.00	17.00	22.00	17.00	11.00	8.50	...
6	150	24.00	20.00	24.00	29.00	24.00	20.00	12.00	10.00	24.00
8	200	29.00	26.00	29.00	32.00	29.00	26.00	14.50	13.00	29.00
10	250	33.00	31.00	33.00	38.00	33.00	31.00	16.50	15.50	33.00
12	300	38.00	36.00	38.00	44.00	38.00	36.00	19.00	18.00	38.00
14	350	40.50	39.00	40.50	39.00	20.25	19.50	40.50
16	400	44.50	43.00	44.50 (5)	...	44.50 (6)	43.00	26.00	...	44.50
18	450	48.00	48.00 (6)	...	29.00	...	48.00
20	500	52.00	...	52.00 (5)	...	52.00 (6)	...	32.50	...	52.00
22	550
24	600	61.00	61.00 (6)	...	39.00	...	61.00

GENERAL NOTES:

- (a) Dimensions are in inches.
- (b) See Table A9 for adjustments to tabulated dimensions which may be required for certain flange facings.

NOTES:

- (1) These dimensions apply to pressure seal or flangeless bonnet valves. They may be applied at the manufacturer's option to valves with flanged bonnets.
- (2) The connecting end flanges for Class 900 valves, NPS 2 1/2 and smaller, are identical to those of Class 1500 valves. The face-to-face dimensions for all Class 900 valves, NPS 2 1/2 and smaller, except round port full bore plug valves (column 4), are identical with those of Class 1500 valves
- (3) Solid wedge only.
- (4) Regular pattern only.
- (5) Venturi pattern only.
- (6) Swing check only.

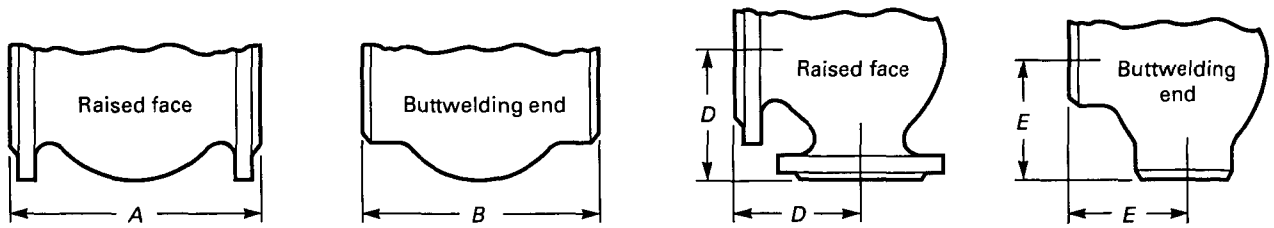

TABLE A5 CLASS 1500 STEEL FLANGED AND BUTTWELDING END VALVES, FACE-TO-FACE AND END-TO-END DIMENSIONS

		1	2	3	4	5	6	7	8
		Class 1500 Steel							
		Flanged End (0.25 in. Raised Face) and Welding End							
		Gate		Plug		Globe, Lift Check, and Swing Check, Long Pattern, A and B	Globe, Lift Check, and Swing Check, Short Pattern [Note (1)], B	Angle and Lift Check, Long Pattern, D and E	Ball
Nominal Valve Size		Solid Wedge, Double Disc, and Conduit, Long Pattern, A and B	Short Pattern [Note (1)], B	Regular and Venturi Pattern, A and B	Round Port, Full Bore, A				Long Pattern, A and B
NPS	DN								
1/2	15	8.50 (5)	...	4.25	...
3/4	20	9.00	...	4.50	...
1	25	10.00 (2)	5.50	10.00 (3)	...	10.00	...	5.00	...
1 1/4	32	11.00 (2)	6.50	11.00 (3)	...	11.00	...	5.50	...
1 1/2	40	12.00 (2)	7.00	12.00 (3)	...	12.00	...	6.00	...
2	50	14.50	8.50	14.50 (3)	15.38	14.50	8.50	7.25	14.50
2 1/2	65	16.50	10.00	16.50 (3)	17.88	16.50	10.00	8.25	16.50
3	80	18.50	12.00	18.50 (3)	20.62	18.50	12.00	9.25	18.50
4	100	21.50	16.00	21.50 (3)	24.62	21.50	16.00	10.75	21.50
5	125	26.50	19.00	26.50	19.00	13.25	...
6	150	27.75	22.00	27.75	31.00	27.75	22.00	13.88	27.75
8	200	32.75	28.00	32.75	35.00	32.75	28.00	16.38	32.75
10	250	39.00	34.00	39.00	42.00	39.00	34.00	19.50	39.00
12	300	44.50	39.00	44.50	48.00	44.50	39.00	22.25	44.50
14	350	49.50	42.00	49.50	42.00	24.75	49.50
16	400	54.50	47.00	54.50 (4)	...	54.50 (6)	47.00	...	54.50
18	450	60.50	53.00	60.50 (6)
20	500	65.50	58.00	65.50 (6)
22	550
24	600	76.50	76.50 (6)

(continued)

TABLE A5 (CONT'D)

GENERAL NOTES:

- (a) Dimensions are in inches.
- (b) See Table A9 for adjustments to tabulated dimensions which may be required for certain flange facings.

NOTES:

- (1) These dimensions apply to pressure seal or flangeless bonnet valves. They may be applied at the manufacturer's option to valves with flanged bonnets.
- (2) Solid wedge only.
- (3) Regular pattern only.
- (4) Venturi pattern only.
- (5) Globe and lift check only.
- (6) Swing check only.

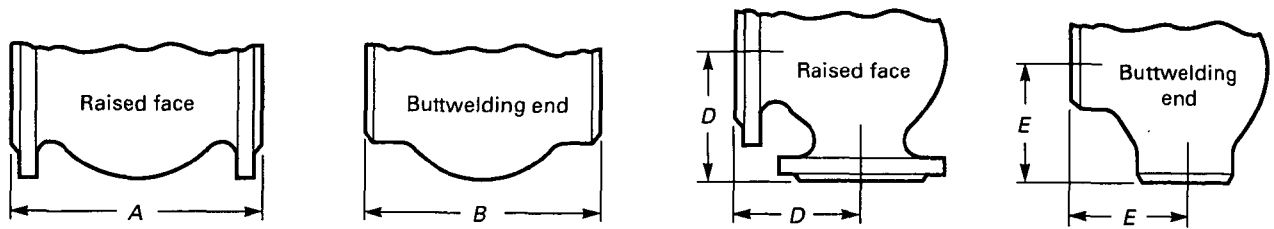

TABLE A6 CLASS 2500 STEEL FLANGED AND BUTTWELDING END VALVES, FACE-TO-FACE AND END-TO-END DIMENSIONS

		1	2	3	4	5	6	7
		Class 2500 Steel						
		Flanged End (0.25 in. Raised Face) and Welding End						
		Gate		Plug, Regular Pattern, A and B	Globe, Lift Check, and Swing Check, Long Pattern, A and B	Globe, Lift Check, and Swing Check, Short Pattern [Note (1)], B	Angle and Lift Check, Long Pattern, D and E	Ball
Nominal Valve Size	DN	Solid Wedge, and Double Disc, Long Pattern, A and B	Short Pattern [Note (1)], B					Long Pattern, A and B
1/2	15	10.38 (2)	10.38	...	5.19	...
3/4	20	10.75 (2)	10.75	...	5.38	...
1	25	12.12 (2)	7.31	12.12	12.12	...	6.06	...
1 1/4	32	13.75 (2)	9.12	...	13.75	...	6.88	...
1 1/2	40	15.12 (2)	9.12	15.12	15.12	...	7.56	...
2	50	17.75	11.00	17.75	17.75	11.00	8.88	17.75
2 1/2	65	20.00	13.00	20.00	20.00	13.00	10.00	20.00
3	80	22.75	14.50	22.75	22.75	14.50	11.38	22.75
4	100	26.50	18.00	26.50	26.50	18.00	13.25	26.50
5	125	31.25	21.00	31.25	31.25	21.00	15.62	...
6	150	36.00	24.00	36.00	36.00	24.00	18.00	36.00
8	200	40.25	30.00	40.25	40.25	30.00	20.12	40.25
10	250	50.00	36.00	50.00	50.00	36.00	25.00	50.00
12	300	56.00	41.00	56.00	56.00	41.00	28.00	56.00
14	350	...	44.00
16	400	...	49.00
18	450	...	55.00

GENERAL NOTES:

(a) Dimensions are in inches.

(b) See Table A9 for adjustments to tabulated dimensions which may be required for certain flanged facings.

NOTES:

(1) These dimensions apply to pressure seal or flangeless bonnet valves. They may be applied at the manufacturer's option to valves with flanged bonnets.

(2) Solid wedge only.

TABLE A7 CLASSES 125 AND 250 CAST IRON AND CLASSES 150 TO 2500 STEEL WAFER TYPE VALVES, FACE-TO-FACE DIMENSIONS

		1	2	3	4	5	6	7	8	9	10	11	12	13	14
Nominal Valve Size		Steel [Note (1)]	Cast Iron [Note (2)]		Swing Check, Single and Dual Plate, Installation Between Standard ANSI Flanges [Note (3)]										
			Swing Check, Single and Dual Plate, Installation Between Standard ANSI Flanges												
		Bonnet-less Knife Gate, Class 150 Flange Mating Dimensions	Class					Class							
			Class		150	300	600	900	1500	2500	150	300	600	900	1500
NPS	DN	125	250	Long Pattern [Note (4)]					Short Pattern [Note (5)]						
2	50	1.88	2.12	2.12	2.38	2.38	2.38	2.75	2.75	2.75	0.75	0.75	0.75	0.75	0.75
2½	65	...	2.38	2.38	2.62	2.62	2.62	3.25	3.25	3.25	0.75	0.75	0.75	0.75	0.75
3	80	2.00	2.62	2.62	2.88	2.88	2.88	3.25	3.25	3.38	0.75	0.75	0.75	0.75	0.88
4	100	2.00	2.62	2.62	2.88	2.88	3.12	4.00	4.00	4.12	0.75	0.75	0.88	0.88	1.25
5	125	2.25	3.25	3.25
6	150	2.25	3.75	3.75	3.88	3.88	5.38	6.25	6.25	6.25	0.75	0.88	1.12	1.38	1.75
8	200	2.75	5.00	5.00	5.00	5.00	6.50	8.12	8.12	8.12	1.12	1.12	1.50	1.75	2.25
10	250	2.75	5.50	5.50	5.75	5.75	8.38	9.50	9.75	10.00	1.12	1.50	2.25	2.25	2.88
12	300	3.00	7.12	7.12	7.12	7.12	9.00	11.50	12.00	12.00	1.50	2.00	2.38
14	350	3.00	7.25	8.75	7.25	8.75	10.75	14.00	14.00	...	1.75	2.00	2.62
16	400	3.50	7.50	9.12	7.50	9.12	12.00	15.12	15.12	...	2.00	2.00	2.88
18	450	3.50	8.00	10.38	8.00	10.38	14.25	17.75	18.44	...	2.38	3.00	3.25
20	500	4.50	8.38	11.50	8.62	11.50	14.50	17.75	21.00	...	2.50	3.25	3.62
24	600	4.50	8.75	12.50	8.75	12.50	17.25	19.50	22.00
30	750	...	12.00	14.50	12.00	14.50	19.88
36	900	...	14.50	19.00	14.50	19.00	25.00
42	1050	...	17.00	22.38	17.00	22.38	27.62
48	1200	...	20.62	24.75	20.62	24.75

GENERAL NOTES:

- (a) Dimensions are in inches.
- (b) The tolerances of para. 5.1 apply to face-to-face dimensions for sizes NPS 24 and smaller. For sizes NPS 30 and larger, the tolerance shall be ± 0.25 in.

NOTES:

- (1) These data for knife gate valves are extracted from TAPPI TIS 405-8 and MSS-SP-81.
- (2) These data for cast iron swing check valves are extracted from API 594.
- (3) Valves of sizes NPS 30 and larger in Classes 150, 300, and 600 shall have body outside diameters and gasket surface dimensions compatible with flange standards specified in the purchase order, e.g., API 605 or MSS SP-44.
- (4) These data for long pattern steel swing check valves in sizes NPS 24 and smaller are extracted from API 6D and API 594. Data for larger sizes are extracted from API 594.
- (5) These data for short pattern steel swing check valves are extracted from API 6D.

TABLE A8 CLASSES 25 AND 125 CAST IRON AND CLASSES 150 TO 600 STEEL BUTTERFLY VALVES, FACE-TO-FACE DIMENSIONS

Nominal Valve Size		1	2	3	4	5	6	7	8	9
		Cast Iron and Class 150 Steel [Notes (2), (3), and (4)]					Steel Grooved End [Notes (2), (4)]	Steel Offset Seat Lug and Wafer Style [Notes (5), (6)]		
		Flanged End		Lug and Wafer Style [Note (1)]			Class 150	Class 150	Class 300	Class 600
Narrow	Wide	Narrow	Wide	Extra Wide						
1½	40	1.31	1.44	1.50	3.38
2	50	1.69	1.75	1.81	3.19
2½	65	1.81	1.94	2.00	3.81
3	80	5.00	5.00	1.81	1.94	2.00	3.81	1.88	1.88	2.12
4	100	5.00	7.00	2.06	2.19	2.25	4.56	2.12	2.12	2.50
5	125	5.00	7.50	2.19	2.50	2.56	5.81
6	150	5.00	8.00	2.19	2.75	2.81	5.81	2.25	2.31	3.06
8	200	6.00	8.50	2.38	2.81	2.94	5.25	2.50	2.88	4.00
10	250	8.00	15.00	2.69	3.00	3.12	6.25	2.81	3.25	4.62
12	300	8.00	15.00	3.06	3.25	3.38	6.50	3.19	3.62	5.50
14	350	8.00	16.00	3.06	3.62	3.75	7.00	3.62	4.62	6.12
16	400	8.00	16.00	3.12	4.00	4.12	7.00	4.00	5.25	7.00
18	450	8.00	16.00	4.00	4.50	4.62	8.00	4.50	5.88	7.88
20	500	8.00	18.00	4.38	5.00	5.12	8.50	5.00	6.25	8.50
24	600	8.00	18.00	...	6.06	6.19	10.00	6.06	7.12	9.13
30	750	12.00	22.00	...	6.50
36	900	12.00	22.00	...	7.88
42	1050	12.00	24.00	...	9.88
48	1200	15.00	26.00	...	10.88
54	1350	15.00	28.00
60	1500	15.00	30.00
66	1650	18.00	34.00
72	1800	18.00	36.00

GENERAL NOTE: Dimensions are in inches.

NOTES:

- (1) The installed face-to-face dimension is the dimension of the valve face-to-face after installation in the pipeline. It does not include the thickness of gaskets where separate gaskets are used. It does include the compressed (installed) thickness of gaskets or seals that are an integral part of the valve.
- (2) These butterfly valves are of the design generally having concentric location of disc and seat, covered by MSS SP-67, from which these data are extracted.
- (3) These valves are dimensionally compatible with flanges conforming to ASME B16.1 Class 25 or Class 125, ASME B16.5 Class 150, ASME B16.24 Class 150, ASME B16.42 Class 150, or AWWA C-207.
- (4) For these butterfly valves, a tolerance of ±0.06 in. shall be allowed on face-to-face dimensions of valves of NPS 6 and smaller, and a tolerance of ±0.13 in. on NPS 8 and larger, except that for single flange and flangeless valves of NPS 30 and larger, a tolerance of ±0.25 in. shall be allowed.
- (5) For these valves, a tolerance of ±0.13 in. shall be allowed on the face-to-face dimensions for all sizes and pressure classes.
- (6) The data for offset seat valves, columns 7-9, are extracted from MSS SP-68 and API 609 (except 16"-24" Class 600, which are only in MSS SP-68).

TABLE A9 DETERMINATION OF FACE-TO-FACE AND END-TO-END DIMENSIONS OF FLANGED VALVES HAVING VARIOUS FLANGE FACINGS

Material	Class	Flat Face	Face-to-Face [Notes (1) and (2)]				End-to-End [Notes (1) and (2)]		
			0.06 in. Raised Face	0.25 in. Raised Face	Large or Small		Ring Type Joint	Large or Small	
					Male Face	Tongue Face		Female Face	Groove Face
Cast iron	125	(3)
	250	...	(3)
Steel	150	(4)	(3)	...	+0.50	+0.50	(6)	+0.38	+0.38
	300	(4)	(3)	...	+0.50	+0.50	(6)	+0.38	+0.38
	600 to 2500	(3)	(5)	(5)	(6)	-0.12	-0.12

GENERAL NOTE: Dimensions are in inches.

NOTES:

- (1) To determine the face-to-face or end-to-end dimensions of valves having both flanges as tabulated in this table, adjust the face-to-face (not the butt-weld end-to-end) dimensions shown for the valve type (gate, globe, etc.); material, class, and size in Tables A1 to A6 by the amount shown:
- (2) For center-to-face or center-to-end dimensions of angle type valves, use one-half the numerical adjustment shown herein.
- (3) These face-to-face dimensions are listed in Tables A1 to A7 (See table of desired class.)
- (4) For Class 150 and for Class 300 steel valves having flat faces, either the full thickness of the flange or the thickness with the 0.06 in. raised face removed may be supplied unless otherwise specified. For full thickness of flange, the face-to-face dimensions listed for 0.06 in. raised face apply. Users are reminded that removing the 0.06 in. raised faces will make the face-to-face dimensions nonstandard.
- (5) These face-to-face dimensions are those listed for 0.25 in. raised face in Tables A3 to A6.
- (6) The X dimensions given in Table A10 added to the appropriate raised face flange face-to-face dimensions of Tables A1 to A6 establish the end-to-end dimensions of steel valves having flanges with ring joint facings.

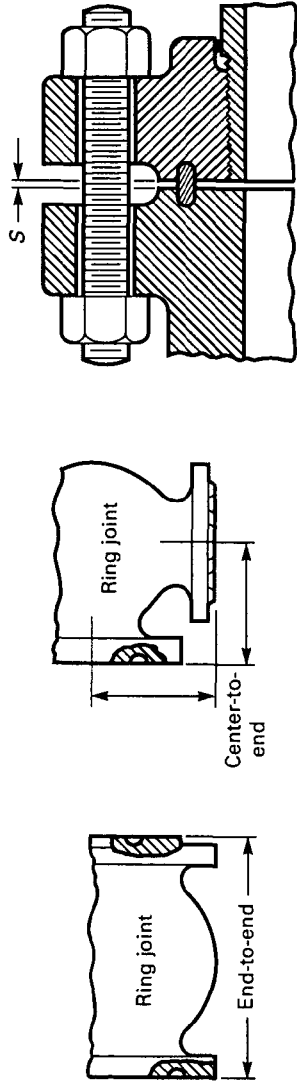

TABLE A10 CLASSES 150 TO 2500 STEEL VALVES HAVING END FLANGES WITH RING JOINT FACINGS, END-TO-END DIMENSIONS

Nominal Valve Size	Class 150		Class 300		Class 600		Class 900		Class 1500		Class 2500	
	NPS	DN	X	S	X	S	X	S	X	S	X	S
1/2	15	40	0.50	0.16	0.44	0.12	0.12	0	0.16	0	0.16	0
3/4	20	50	0.50	0.16	0.50	0.16	0.16	0	0.16	0	0.16	0
1	25	65	0.50	0.16	0.50	0.16	0.16	0	0.16	0	0.16	0
1 1/4	32	80	0.50	0.16	0.50	0.16	0.16	0	0.16	0	0.16	0
1 1/2	40	100	0.50	0.16	0.50	0.16	0.16	0	0.16	0	0.16	0
2	50	125	0.50	0.16	0.62	0.22	0.19	0.12	0.12	0.12	0.12	0.12
2 1/2	65	150	0.50	0.16	0.62	0.22	0.19	0.12	0.12	0.12	0.12	0.12
3	80	200	0.50	0.16	0.62	0.22	0.19	0.12	0.12	0.12	0.12	0.12
4	100	250	0.50	0.16	0.62	0.22	0.19	0.12	0.12	0.12	0.12	0.12
5	125	300	0.50	0.16	0.62	0.22	0.19	0.12	0.12	0.12	0.12	0.12
6	150	350	0.50	0.16	0.62	0.22	0.19	0.12	0.12	0.12	0.12	0.12
8	200	400	0.50	0.16	0.62	0.22	0.19	0.12	0.12	0.12	0.12	0.12
10	250	450	0.50	0.16	0.62	0.22	0.19	0.12	0.12	0.12	0.12	0.12
12	300	500	0.50	0.16	0.62	0.22	0.19	0.12	0.12	0.12	0.12	0.12
14	350	550	0.50	0.12	0.62	0.22	0.19	0.38	0.16	0.75	0.22	0.22
16	400	600	0.50	0.12	0.62	0.22	0.19	0.38	0.16	0.75	0.22	0.22
18	450	500	0.50	0.12	0.62	0.22	0.19	0.38	0.16	0.75	0.22	0.22
20	500	550	0.50	0.12	0.62	0.22	0.19	0.38	0.16	0.75	0.22	0.22
22	550	600	0.50	0.12	0.62	0.22	0.19	0.38	0.16	0.75	0.22	0.22
24	600		0.50	0.12	0.62	0.22	0.19	0.38	0.16	0.75	0.22	0.22

(continued)

TABLE A10 CLASSES 150 TO 2500 STEEL VALVES HAVING END FLANGES WITH RING JOINT FACINGS, END-TO-END DIMENSIONS (CONT'D)

Nominal Valve Size	Class 150		Class 300		Class 600		Class 900		Class 1500		Class 2500	
	1	2	3	4	5	6	7	8	9	10	11	12
NPS DN	X	S	X	S	X	S	X	S	X	S	X	S
26	1.00 (1)	0.25	0.50 (1)	0.22
28	1.00 (1)	0.25	0.50 (1)	0.22
30	1.00 (1)	0.25	0.50 (1)	0.22
32	1.12 (1)	(2)	0.62 (1)	(2)
34	1.12 (1)	(2)	0.62 (1)	(2)
36	1.12 (1)	(2)	0.62 (1)	(2)

GENERAL NOTES:

- (a) Dimensions are in inches.
- (b) Flanges conform to those of ASME B16.5 for the corresponding size and pressure class, except in NPS 22, NPS 26, and larger sizes. See Note (1).
- (c) To determine the end-to-end dimensions of valves having flanges with ring joint facings, the X dimensions must be added to the nominal raised face flange face-to-face dimensions of Tables A1 to A6. For angle and angle lift check valves, one-half of the X dimensions as listed in this table must be added to the nominal dimensions for center-to-end dimensions. For approximate distance between ends of flanges having octagonal or oval ring gaskets, when rings are compressed, use S dimensions as listed in this table.

NOTES:

- (1) Flanges for NPS 22, NPS 26, and larger sizes conform to those of MSS SP-44 and ASME B16.47, Series A for the corresponding size and pressure class.
- (2) S dimension is not determined.
- (3) This dimension has a minus value because the height of the applicable ring joint face is 0.22 in., whereas the height of the raised face is 0.25 in.

MANDATORY ANNEX I REFERENCES

The following is a list of publications referenced in this Standard.

API 6D, Twenty-First Edition, Pipeline Valves (Steel Gate, Plug, Ball, and Check Valves)

API 594, Fifth Edition, Wafer and Wafer-Lug Check Valves

API 609, Fifth Edition, Lug-and-Wafer-Type Butterfly Valves

Publisher: American Petroleum Institute (API), Production Department, 2535 One Main Place, Dallas, TX 75201-3688

ASME B16.1-1989, Cast Iron Pipe Flanges and Flanged Fittings, Class 25, 125, 250, and 800

ASME B16.5-1996, Pipe Flanges and Flanged Fittings

ASME B16.24-1991, Cast Copper Alloy Pipe Flanges and Flanged Fittings, Class 150, 300, 400, 600, 900, 1500, and 2500

ASME B16.34-1996, Valves — Flanged and Butt-welding End — Steel, Nickel Alloy, and Other Special Alloys

ASME B16.42-1987, Ductile Iron Pipe Flanges and Flanged Fittings, Class 150 and 300

ASME B16.47-1996, Large Diameter Steel Flanges NPS 26 through NPS 60

Publisher: The American Society of Mechanical Engineers (ASME), Three Park Avenue, New York, NY 10016; Order Department: 22 Law Drive, Box 2300, Fairfield, NJ 07007

AWWA C207-94, Steel Pipe Flanges

Publisher: American Water Works Association (AWWA), 6666 W. Quincy Avenue, Denver, CO 80235

MSS SP-44-1996, Steel Pipe Line Flanges

MSS-SP-67-1995, Butterfly Valves

MSS-SP-81-1995, Stainless Steel Bonnetless, Flanged Knife Gate Valves

Publisher: Manufacturers Standardization Society of the Valve and Fittings Industry (MSS), 127 Park Street, N.E., Vienna, VA 22180

TAPPI TIS 405-8-1981, Recommendations for Stainless Steel, Bonnetless, Flanged, Wafer, and Knife Gate Valves

Publisher: Technical Association of the Pulp and Paper Industry (TAPPI), Technology Park/Atlanta, P.O. Box 105113, Atlanta, GA 30348

Publications appearing above that have been approved as American National Standards may also be obtained from the American National Standards Institute (ANSI), 11 West 42nd Street, New York, NY 10036.

ASME Services

ASME is committed to developing and delivering technical information. At ASME's Information Central, we make every effort to answer your questions and expedite your orders. Our representatives are ready to assist you in the following areas:

ASME Press
Codes & Standards
Credit Card Orders
IMEchE Publications
Meetings & Conferences
Member Dues Status

Member Services & Benefits
Other ASME Programs
Payment Inquiries
Professional Development
Short Courses
Publications

Public Information
Self-Study Courses
Shipping Information
Subscriptions/Journals/Magazines
Symposia Volumes
Technical Papers

How can you reach us? It's easier than ever!

There are four options for making inquiries* or placing orders. Simply mail, phone, fax, or E-mail us and an Information Central representative will handle your request.

Mail
ASME
22 Law Drive, Box 2900
Fairfield, New Jersey
07007-2900

Call Toll Free
US & Canada: 800-THE-ASME
(800-843-2763)
Mexico: 95-800-THE-ASME
(95-800-843-2763)
Universal: 973-882-1167

Fax—24 hours
973-882-1717
973-882-5155

E-Mail—
24 hours
Infocentral@asme.org

* Information Central staff are not permitted to answer inquiries about the technical content of this code or standard. Information as to whether or not technical inquiries are issued to this code or standard is shown on the copyright page. All technical inquiries must be submitted in writing to the staff secretary. Additional procedures for inquiries may be listed within.

AMERICAN NATIONAL STANDARDS FOR PIPING, PIPE FLANGES, FITTINGS, AND VALVES

Scheme for the Identification of Piping Systems	A13.1-1996
Pipe Threads, General Purpose (Inch)	B1.20.1-1983(R1992)
Dryseal Pipe Threads (Inch)	B1.20.3-1976(R1998)
Cast Iron Pipe Flanges and Flanged Fittings: Classes 25, 125, and 250	B16.1-1998
Malleable Iron Threaded Fittings: Classes 150 and 300	B16.3-1998
Gray Iron Threaded Fittings: Classes 125 and 250	B16.4-1998
Pipe Flanges and Flanged Fittings (NPS ½ Through NPS 24)	B16.5-1996
Factory-Made Wrought Butt welding Fittings	B16.9-2001
Face-to-Face and End-to-End Dimensions of Valves	B16.10-2000
Forged Fittings, Socket-Welding and Threaded	B16.11-1996
Cast Iron Threaded Drainage Fittings	B16.12-1998
Ferrous Pipe Plugs, Bushings, and Locknuts with Pipe Threads	B16.14-1991
Cast Bronze Threaded Fittings: Classes 125 and 250	B16.15-1985(R1994)
Cast Copper Alloy Solder Joint Pressure Fittings	B16.18-1984(R1994)
Metallic Gaskets for Pipe Flanges: Ring-Joint, Spiral-Wound, and Jacketed	B16.20-1998
Nonmetallic Flat Gaskets for Pipe Flanges	B16.21-1992
Wrought Copper and Copper Alloy Solder Joint Pressure Fittings	B16.22-1995
Cast Copper Alloy Solder Joint Drainage Fittings — DWV	B16.23-1992
Cast Copper Alloy Pipe Flanges and Flanged Fittings: Class 150, 300, 400, 600, 900, 1500, and 2500	B16.24-1991(R1998)
Butt welding Ends	B16.25-1997
Cast Copper Alloy Fittings for Flared Copper Tubes	B16.26-1988
Wrought Steel Butt welding Short Radius Elbows and Returns	B16.28-1994
Wrought Copper and Wrought Copper Alloy Solder Joint Drainage Fittings — DWV	B16.29-1994
Manually Operated Metallic Gas Valves for Use in Gas Piping Systems up to 125 psig (Sizes ½ Through 2)	B16.33-1990
Valves — Flanged, Threaded, and Welding End	B16.34-1996
Orifice Flanges	B16.36-1996
Large Metallic Valves for Gas Distribution (Manually Operated, NPS 2½ to 12, 125 psig Maximum)	B16.38-1985(R1994)
Malleable Iron Threaded Pipe Unions	B16.39-1998
Manually Operated Thermoplastic Gas Shutoffs and Valves in Gas Distribution Systems	B16.40-1985(R1994)
Functional Qualification Requirements for Power Operated Active Valve Assemblies for Nuclear Power Plants	B16.41-1983(R1989)
Ductile Iron Pipe Flanges and Flanged Fittings, Classes 150 and 300	B16.42-1998
Manually Operated Metallic Gas Valves for Use in House Piping Systems	B16.44-1995
Cast Iron Fittings for Solvent® Drainage Systems	B16.45-1998
Large Diameter Steel Flanges (NPS 26 Through NPS 60)	B16.47-1996
Steel Line Blanks	B16.48-1997
Factory-Made Wrought Steel Butt welding Induction Bends for Transportation and Distribution Systems	B16.49-2000
Power Piping	B31.1-1998
Fuel Gas Piping (not an ANSI standard)	B31.2-1968
Process Piping	B31.3-1999
Pipeline Transportation Systems for Liquid Hydrocarbons and Other Liquids	B31.4-1998
Refrigeration Piping and Heat Exchanger Components	B31.5-2000
Gas Transmission and Distribution Piping Systems	B31.8-1999
Building Services Piping	B31.9-1996
Slurry Transportation Piping Systems	B31.11-1989(R1998)
Manual for Determining the Remaining Strength of Corroded Pipelines	B31G-1991
Welded and Seamless Wrought Steel Pipe	B36.10M-1996
Stainless Steel Pipe	B36.19M-1985(R1994)
Self-Operated and Power-Operated Safety-Related Valves Functional Specification Standard	N278.1-1975(R1992)

The ASME Publications Catalog shows a complete list of all the Standards published by the Society. For a complimentary catalog, or the latest information about our publications, call 1-800-THE-ASME (1-800-843-2763).

ISBN 0-7918-2659-7

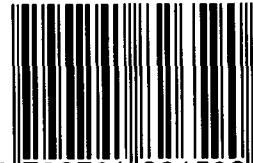

9 790791 826590



J03100